

Dell PowerEdge R630 Owner's Manual

Regulatory Model: E26S Series
Regulatory Type: E26S001



Notes, Cautions, and Warnings

 **NOTE:** A NOTE indicates important information that helps you make better use of your computer.

 **CAUTION:** A CAUTION indicates either potential damage to hardware or loss of data and tells you how to avoid the problem.

 **WARNING:** A WARNING indicates a potential for property damage, personal injury, or death.

Copyright © 2014 Dell Inc. All rights reserved. This product is protected by U.S. and international copyright and intellectual property laws. Dell™ and the Dell logo are trademarks of Dell Inc. in the United States and/or other jurisdictions. All other marks and names mentioned herein may be trademarks of their respective companies.

2014 - 09

Rev. A00

Contents

1 About your system.....	8
Supported configurations.....	8
Front-panel features and indicators.....	8
LCD panel features.....	13
Home screen.....	14
Setup menu.....	14
View menu.....	15
Diagnostic indicators.....	15
Hard-drive indicator codes.....	17
iDRAC Direct LED indicator codes.....	18
Quick Sync indicator codes.....	19
Back-panel features and indicators.....	20
NIC indicator codes.....	23
Power indicator codes.....	23
Documentation matrix.....	26
Quick Resource Locator	27
2 Performing initial system configuration	28
Setting up your system.....	28
Methods of setting up and configuring the iDRAC IP address	28
Information about logging in to iDRAC.....	29
Methods of installing the operating system.....	29
Remote management	29
Downloading and installing drivers and firmware.....	29
3 Pre-operating system management applications.....	31
Navigation keys.....	31
About System Setup.....	32
Entering System Setup.....	32
System Setup Main Menu.....	32
System BIOS screen.....	32
System Information screen details.....	33
Memory Settings screen details.....	34
Processor Settings screen details.....	35
SATA Settings screen details.....	36
Boot Settings screen details.....	39
Network Settings screen details.....	40
Integrated Devices screen details.....	40

Serial Communication screen details.....	42
System Profile Settings screen details.....	42
System Security settings screen details.....	44
Miscellaneous Settings screen details.....	46
About Boot Manager.....	47
Entering Boot Manager	47
Boot Manager main menu.....	47
Changing the boot order.....	47
Choosing the system boot mode.....	48
Assigning a system and setup password.....	48
Deleting or changing an existing system password and setup password.....	49

4 Installing and removing system components.....50

Safety instructions.....	50
Before working inside your system.....	50
After working inside your system.....	50
Recommended tools.....	51
Front bezel (optional).....	51
Removing the front bezel.....	51
Installing the front bezel.....	52
Removing the system cover.....	52
Installing the system cover.....	53
Inside the system.....	54
Cooling shroud.....	56
Removing the cooling shroud.....	56
Installing the cooling shroud.....	57
System memory.....	57
General memory module installation guidelines.....	59
Mode-specific guidelines.....	59
Sample memory configurations.....	61
Removing memory modules.....	63
Installing memory modules.....	65
Hard drives.....	66
Removing a 2.5 inch hard-drive blank.....	67
Installing a 2.5 inch hard-drive blank.....	67
Removing a 1.8 inch hard-drive blank.....	68
Installing a 1.8 inch hard-drive blank.....	68
Removing a hot-swap hard drive.....	69
Installing a hot-swap hard drive.....	71
Removing a hard drive from a hard-drive carrier.....	71
Installing a hard drive into a hard-drive carrier.....	72
Removing a 1.8 inch hard drive from a hard-drive carrier.....	72

Installing a 1.8 inch hard drive into a hard-drive carrier.....	73
Optical drive (optional).....	73
Removing the optical drive.....	73
Installing the optical drive.....	74
Removing the slim optical drive blank.....	75
Installing the slim optical drive blank.....	76
Cooling fans.....	76
Removing a cooling fan.....	77
Installing a cooling fan.....	78
Internal USB memory key (optional).....	78
Replacing the internal USB key.....	78
Expansion cards and expansion-card risers.....	79
Expansion card installation guidelines.....	79
Removing an expansion card.....	80
Installing an expansion card.....	81
Removing expansion-card risers.....	82
Installing expansion card risers.....	84
SD vFlash media card.....	85
Replacing a SD vFlash card.....	85
Internal dual SD module.....	85
Removing the internal dual SD module	86
Installing the internal dual SD module	88
Internal SD card.....	88
Removing an internal SD Card.....	88
Installing an internal SD card.....	89
Integrated storage controller card.....	89
Removing the integrated storage controller card.....	89
Installing the integrated storage controller card.....	91
Network daughter card.....	91
Removing the network daughter card.....	91
Installing the network daughter card.....	93
Processors.....	93
Removing a processor.....	93
Installing a processor.....	97
Power supply units.....	99
Hot Spare feature.....	99
Removing the power supply unit blank.....	100
Installing the power supply unit blank.....	101
Removing an AC power supply unit.....	101
Installing an AC power supply unit.....	102
Wiring instructions for a DC power supply unit.....	103
Removing a DC power supply unit.....	104

Installing a DC power supply unit.....	105
System battery.....	105
Replacing the system battery.....	105
Hard-drive backplane.....	107
Removing the hard-drive backplane.....	107
Installing the hard-drive backplane.....	113
Control Panel Assembly.....	114
Removing the control panel board–8 hard drive system.....	114
Installing the control panel board–8 hard drive system.....	115
Removing the control panel–8 hard–drive system.....	116
Installing the control panel–8 hard drive system.....	117
Removing the control panel–10 hard–drive and 24–hard drive system.....	118
Installing the control panel–10 hard–drive system and 24 hard–drive system.....	119
VGA Module.....	120
Removing the VGA module.....	120
Installing the VGA module.....	121
System board.....	122
Removing the system board.....	122
Installing the system board.....	124
Trusted Platform Module.....	126
Installing the Trusted Platform Module	126
Re-enabling the TPM for BitLocker users.....	127
Re-enabling the TPM for TXT users.....	127

5 Troubleshooting your system..... 129

Safety first—for you and your system.....	129
Troubleshooting system startup failure.....	129
Troubleshooting external connections.....	129
Troubleshooting the video subsystem.....	129
Troubleshooting a USB device.....	129
Troubleshooting iDRAC Direct (USB XML configuration).....	130
Troubleshooting iDRAC Direct (laptop connection).....	131
Troubleshooting a serial I/O device.....	131
Troubleshooting a NIC.....	131
Troubleshooting a wet system.....	132
Troubleshooting a damaged system.....	133
Troubleshooting the system battery.....	133
Troubleshooting power supply units.....	134
Power source problems.....	134
Power supply unit problems.....	134
Troubleshooting cooling problems.....	135
Troubleshooting cooling fans.....	135

Troubleshooting system memory.....	136
Troubleshooting an internal USB key.....	137
Troubleshooting an SD card.....	137
Troubleshooting an optical drive.....	138
Troubleshooting a tape backup unit.....	138
Troubleshooting a hard drive.....	139
Troubleshooting a storage controller.....	140
Troubleshooting expansion cards.....	140
Troubleshooting processors.....	141
System messages.....	142
Warning messages.....	142
Diagnostic messages.....	142
Alert messages.....	142
6 Using system diagnostics.....	143
Dell Embedded System Diagnostics.....	143
When to use the Embedded System Diagnostics.....	143
Running the Embedded System Diagnostics from Boot Manager.....	143
Running the Embedded System Diagnostics from the Dell Lifecycle Controller.....	143
System diagnostic controls.....	144
7 Jumpers and connectors.....	145
System board jumper settings.....	145
System board connectors.....	146
Disabling a forgotten password.....	148
8 Technical specifications.....	149
9 Getting help.....	155
Contacting Dell.....	155
Locating your system service tag.....	155
Documentation feedback.....	155
Quick Resource Locator	155

About your system

The Dell PowerEdge R630 is a rack server that support up to two processors based on the Intel Xeon E5-2600 v3 processor family, up to 24 DIMMs, and storage capacity of up to 28 drive slots.

 **NOTE:** The Dell PowerEdge R630 system supports only internal, hot-swappable hard drives.

Supported configurations

PowerEdge R630 Systems	Configurations
Eight-hard-drive systems	Up to eight 2.5 inch hard drives
Ten-hard-drive systems	Up to ten 2.5 inch hard drives
Twenty four-hard-drive systems	Up to twenty four 1.8 hard drives

Front-panel features and indicators

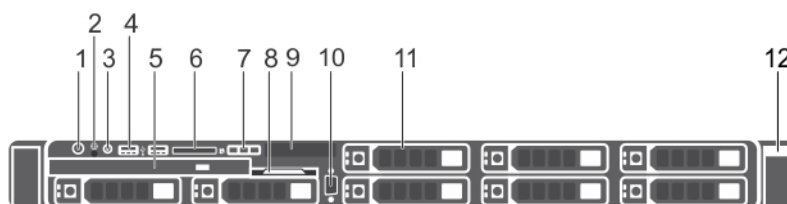









Figure 1. Front-panel features and indicators—8 hard-drive system

Item	Indicator, Button, or Connector	Icon	Description
1	Power-on indicator, power button		The power-on indicator lights when the system power is on. The power button controls the power supply output to the system.

Item	Indicator, Button, or Connector	Icon	Description
			 NOTE: On ACPI-compliant operating systems, turning off the system using the power button causes the system to perform a graceful shutdown before power to the system is turned off.
2	NMI button		<p>Used to troubleshoot software and device driver errors when running certain operating systems. This button can be pressed using the end of a paper clip.</p> <p>Use this button only if directed to do so by qualified support personnel or by the operating system documentation.</p>
3	System identification button		<p>The identification buttons on the front and back panels can be used to locate a particular system within a rack. When one of these buttons is pressed, the LCD panel on the front and the system status indicator on the back flashes blue until one of the buttons is pressed again.</p> <p>Press to toggle the system ID to ON or OFF. If the system stops responding during POST, press and hold the system ID button for more than five seconds to enter BIOS progress mode.</p> <p>To reset the iDRAC (if not disabled in F2 iDRAC setup) press and hold the button for more than 15 seconds.</p>
4	USB management port/ iDRAC Direct (2)		<p>Allows you to connect USB devices to the system or provides access to the iDRAC Direct features. For more information, see the Integrated Dell Remote Access Controller User's Guide at dell.com/esmmanuals. The ports are USB 2.0-compliant.</p>
5	Optical drive (optional)		<p>One optional SATA DVD-ROM drive or DVD+/-RW drive.</p> <p> NOTE: DVD devices are data only.</p>
6	SD vFlash media card slot		<p>Allows you to insert a vFlash media card.</p>
7	LCD menu buttons		<p>Allows you to navigate the control panel LCD menu.</p>
8	Information tag		<p>A slide-out label panel, which allows you to record system information, such as Service Tag, NIC, and MAC address.</p>

Item	Indicator, Button, or Connector	Icon	Description
9	LCD panel		Displays system ID, status information, and system error messages. The LCD lights blue during normal system operation. When the system needs attention, the LCD lights amber and the LCD panel displays an error code followed by descriptive text. NOTE: If the system is connected to AC power and an error is detected, the LCD lights amber regardless of whether the system is turned on or off.
10	Video connector		Allows you to connect a VGA display to the system.
11	Hard drives (8)		Up to eight 2.5 inch hot-swappable hard drives.
12.	Quick Sync		Indicates a Quick Sync enabled system. The Quick Sync feature is optional and requires a Quick Sync bezel. This feature allows management of the system using mobile devices. This feature aggregates hardware/firmware inventory and various system level diagnostic/error information that can be used in troubleshooting the system. For more information, see the Integrated Dell Remote Access Controller User's Guide at dell.com/esmmanuals .

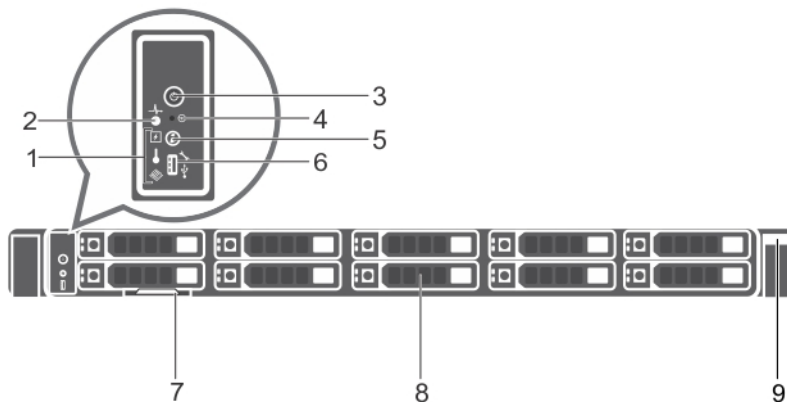



Figure 2. Front-panel features and indicators–10 hard-drive system

Item	Indicator, Button, or Connector	Icon	Description
1	Diagnostic indicators		The diagnostic indicators light up to display error status.
2	System health indicator		The system health indicator blinks amber when a system fault is detected.

Item	Indicator, Button, or Connector	Icon	Description
3	Power-on indicator, power button		<p>The power-on indicator lights when the system power is on. The power button controls the power supply output to the system.</p> <p> NOTE: On ACPI-compliant operating systems, turning off the system using the power button causes the system to perform a graceful shutdown before power to the system is turned off.</p>
4	NMI button		<p>Used to troubleshoot software and device driver errors when running certain operating systems. This button can be pressed using the end of a paper clip.</p> <p>Use this button only if directed to do so by qualified support personnel or by the operating system documentation.</p>
5	System identification button		<p>The identification buttons on the front and back panels can be used to locate a particular system within a rack. When one of these buttons is pressed, the system status indicator on the back flashes until one of the buttons is pressed again. Press to toggle the system ID on and off.</p> <p>If the system stops responding during POST, press and hold the system ID button for more than five seconds to enter BIOS progress mode.</p> <p>To reset the iDRAC (if not disabled in F2 iDRAC setup) press and hold the button for more than 15 seconds.</p>
6	Mini USB connector/ iDRAC Direct		<p>Allows you to connect USB devices to the system or provides access to the iDRAC Direct features. For more information, see the Integrated Dell Remote Access Controller User's Guide at dell.com/esmmanuals. The port is USB 2.0-compliant.</p>
7	Information tag		<p>A slide-out label panel, which allows you to record system information, such as Service Tag, NIC, and MAC address as per your need.</p>
8	Hard drives (10)		<p>Up to ten 2.5 inch hot-swappable hard drives. Up to six 2.5 hot-swappable hard drives and up to four 2.5 inch Dell PowerEdge Express Flash devices (PCIe SSDs).</p>
9	Quick Sync		<p>Indicates a Quick Sync enabled system. The Quick Sync feature is optional and requires a Quick Sync</p>

Item	Indicator, Button, or Connector	Icon	Description
			bezel. This feature allows management of the system using mobile devices. This feature aggregates hardware/firmware inventory and various system level diagnostic/error information that can be used in troubleshooting the system. For more information, see the Integrated Dell Remote Access Controller User's Guide at dell.com/esmanuals .

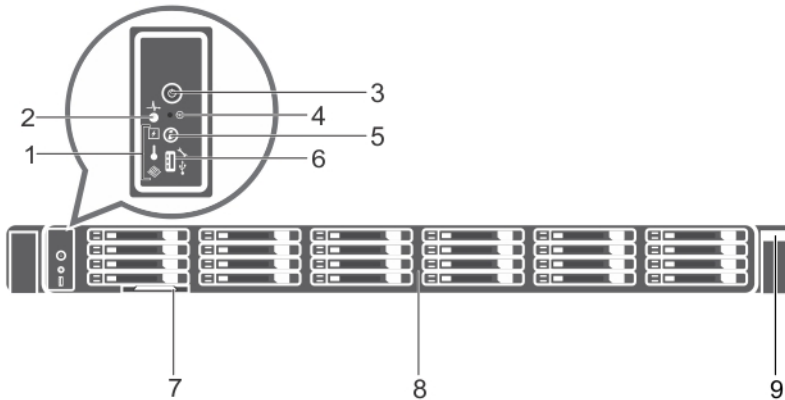







Figure 3. Front-panel features and indicators—24 hard-drive system

Item	Indicator, Button, or Connector	Icon	Description
1	Diagnostic indicators		The diagnostic indicators light up to display error status.
2	System health indicator		The system health indicator blinks amber when a system fault is detected.
3	Power-on indicator, power button		The power-on indicator lights when the system power is on. The power button controls the power supply output to the system. NOTE: On ACPI-compliant operating systems, turning off the system using the power button causes the system to perform a graceful shutdown before power to the system is turned off.
4	NMI button		Used to troubleshoot software and device driver errors when running certain operating systems. This button can be pressed using the end of a paper clip.

Item	Indicator, Button, or Connector	Icon	Description
			Use this button only if directed to do so by qualified support personnel or by the operating system documentation.
5	System identification button		<p>The identification buttons on the front and back panels can be used to locate a particular system within a rack. When one of these buttons is pressed, the system status indicator on the back flashes until one of the buttons is pressed again. Press to toggle the system ID on and off.</p> <p>If the system stops responding during POST, press and hold the system ID button for more than five seconds to enter BIOS progress mode.</p> <p>To reset the iDRAC (if not disabled in F2 iDRAC setup) press and hold the button for more than 15 seconds.</p>
6	Mini USB connector		Allows you to connect USB devices to the system or provides access to the iDRAC Direct features. For more information, see the Integrated Dell Remote Access Controller User's Guide at dell.com/esmmanuals . The port is USB 2.0-compliant.
7	Information tag		A slide-out label panel, which allows you to record system information, such as Service Tag, NIC, MAC address, and so on as per your need.
8	Hard drives (24)		Up to 24 1.8 inch hot-swappable hard drives.
9	Quick Sync		Indicates a Quick Sync enabled system. The Quick Sync feature is optional and requires a Quick Sync bezel. This feature allows management of the system using mobile devices. This feature aggregates hardware/firmware inventory and various system level diagnostic/error information that can be used in troubleshooting the system. For more information, see the Integrated Dell Remote Access Controller User's Guide at dell.com/esmmanuals .

LCD panel features

The LCD panel of your system provides system information and status and error messages to indicate if the system is operating correctly or if the system needs attention. For more information on error messages, see the Dell Event and Error Messages Reference Guide at dell.com/esmmanuals.

- The LCD backlight lights blue during normal operating conditions and lights amber to indicate an error condition.

- The LCD backlight is off when the system is in standby mode and can be turned on by pressing either the Select, Left, or Right button on the LCD panel.
- The LCD backlight remains off if LCD messaging is turned off through the iDRAC utility, the LCD panel, or other tools.

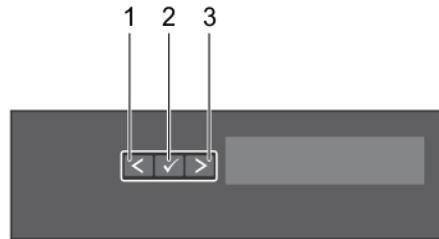





Figure 4. LCD panel features

Item	Button	Description
1	Left	Moves the cursor back in one-step increments.
2	Select	Selects the menu item highlighted by the cursor.
3	Right	Moves the cursor forward in one-step increments. During message scrolling: <ul style="list-style-type: none"> • Press and hold the button to increase scrolling speed. • Release the button to stop.

 **NOTE:** The display will stop scrolling when the button is released. After 45 seconds of inactivity the display will start scrolling.

Home screen

The Home screen displays user-configurable information about the system. This screen is displayed during normal system operation when there are no status messages or errors. When the system is in standby mode, the LCD backlight turns off after five minutes of inactivity if there are no error messages. Press one of the three navigation buttons (Select, Left, or Right) to view the Home screen.

To navigate to the Home screen from another menu, continue to select the up arrow  until the Home icon  is displayed, and then select the Home icon.

From the Home screen, press the Select button to enter the main menu.

Setup menu

 **NOTE:** When you select an option in the Setup menu, you must confirm the option before proceeding to the next action.

Option	Description
iDRAC	Select DHCP or Static IP to configure the network mode. If Static IP is selected, the available fields are IP , Subnet (Sub) , and Gateway (Gtw) . Select Setup DNS to enable DNS and to view domain addresses. Two separate DNS entries are available.
Set error	Select SEL to display LCD error messages in a format that matches the IPMI description in the SEL. This is useful when trying to match an LCD message with an SEL entry. Select Simple to display LCD error messages in a simplified user-friendly description. For more information on error messages, see the Dell Event and Error Messages Reference Guide at dell.com/esmmanuals .
Set home	Select the default information to be displayed on the LCD Home screen. See View menu to see the options and option items that can be set as the default on the Home screen.

View menu

 **NOTE:** When you select an option in the View menu, you must confirm the option before proceeding to the next action.

Option	Description
iDRAC IP	Displays the IPv4 or IPv6 addresses for iDRAC8. Addresses include DNS (Primary and Secondary) , Gateway , IP , and Subnet (IPv6 does not have Subnet).
MAC	Displays the MAC addresses for iDRAC , iSCSI , or Network devices.
Name	Displays the name of the Host , Model , or User String for the system.
Number	Displays the Asset tag or the Service tag for the system.
Power	Displays the power output of the system in BTU/hr or Watts. The display format can be configured in the Set home submenu of the Setup menu.
Temperature	Displays the temperature of the system in Celsius or Fahrenheit. The display format can be configured in the Set home submenu of the Setup menu.







Diagnostic indicators

The diagnostic indicators on the system front panel display error status during system startup.

 **NOTE:** The diagnostic indicators are not present if the system is equipped with an LCD display.

 **NOTE:** The diagnostic indicators are present only on the 10-hard drive and the 24-hard drive systems.

 **NOTE:** No diagnostic indicators are lit when the system is switched off. To start the system, plug it into a working power source and press the power button.

Icon	Description	Condition	Corrective action
	Health indicator	<p>If the system is on, and in good health, the indicator lights solid blue.</p> <p>The indicator blinks amber if the system is on or in standby, and if any error exists (for example, a failed fan or hard drive).</p>	<p>None required.</p> <p>See the System Event Log or system messages for the specific issue. For more information on error messages, see the Dell Event and Error Messages Reference Guide at dell.com/esmmanuals.</p> <p>Invalid memory configurations can cause the system to halt at startup without any video output. See Getting help.</p>
	Hard-drive indicator	The indicator blinks amber if a hard drive experiences an error.	See the System Event Log to determine the hard drive that has an error. Run the appropriate Online Diagnostics test. Restart system and run embedded diagnostics (ePSA). If the hard drives are configured in a RAID array, restart the system and enter the host adapter configuration utility program.
	Electrical indicator	The indicator blinks amber if the system experiences an electrical error (for example, voltage out of range, or a failed power supply or voltage regulator).	See the System Event Log or system messages for the specific issue. If it is due to a problem with the power supply, check the LED on the power supply. Re-seat the power supply by removing and reinstalling it. If the problem persists, see Getting help .
	Temperature indicator	The indicator blinks amber if the system experiences a thermal error (for example, a temperature out of range or fan failure).	<p>Ensure that none of the following conditions exist:</p> <ul style="list-style-type: none"> • A cooling fan is removed or has failed. • System cover, cooling shroud, EMI filler panel, memory-module blank, or back-filler bracket is removed. • Ambient temperature is too high. • External airflow is obstructed. <p>See Getting help.</p>
	Memory indicator	The indicator blinks amber if a memory error occurs.	See the system event log or system messages for the location of the failed memory. Reinstall the memory device. If the problem persists, see Getting help .
	PCIe indicator	The indicator blinks amber if a PCIe card experiences an error.	<p>Restart the system. Update any required drivers for the PCIe card. Re-install the card. If the problem persists, see Getting help.</p> <p> NOTE: For more information on supported PCIe cards, see Expansion Card Installation Guidelines.</p>

Hard-drive indicator codes

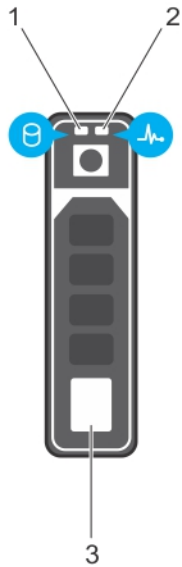



Figure 5. Hard-drive indicators

1. hard-drive activity indicator
2. hard-drive status indicator
3. hard drive

NOTE: If the hard drive is in Advanced Host Controller Interface (AHCI) mode, the status indicator (on the right side) does not function and remains off.

Drive-status indicator pattern (RAID only)	Condition
Blinks green two times per second	Identifying drive or preparing for removal.
Off	Drive ready for insertion or removal.
	NOTE: The drive status indicator remains off until all hard drives are initialized after the system is turned on. Drives are not ready for insertion or removal during this time.
Blinks green, amber, and turns off	Predicted drive failure
Blinks amber four times per second	Drive failed
Blinks green slowly	Drive rebuilding
Steady green	Drive online
Blinks green three seconds, amber three seconds, and turns off six seconds	Rebuild aborted

iDRAC Direct LED indicator codes

 **NOTE:** The iDRAC Direct LED indicator does not light up for the USB mode.

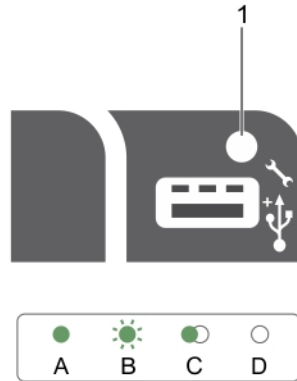

Figure 6. iDRAC Direct LED indicator

1. iDRAC Direct status indicator

The table below displays iDRAC Direct activity when configuring iDRAC Direct by using the management port (USB XML Import).

Convention	iDRAC Direct LED indicator pattern	Condition
A	Green	Lights green for a minimum of 2 seconds at the beginning and end of a file transfer.
B	Flashing green	Indicates file transfer or any operation tasks.
C	Green and turns off	Indicates that the file transfer is complete.
D	Not lit	Indicates that the USB is ready to be removed or that a task is complete.

The table below displays iDRAC Direct activity when configuring iDRAC Direct using your laptop and cable (Laptop Connect).

iDRAC Direct LED indicator pattern	Condition
Solid green for two seconds	Indicates that the laptop is connected.
Flashing green (on for two seconds and off for two seconds)	Indicates that the laptop connected is recognized.
Turns off	Indicates that the laptop is unplugged..

Quick Sync indicator codes

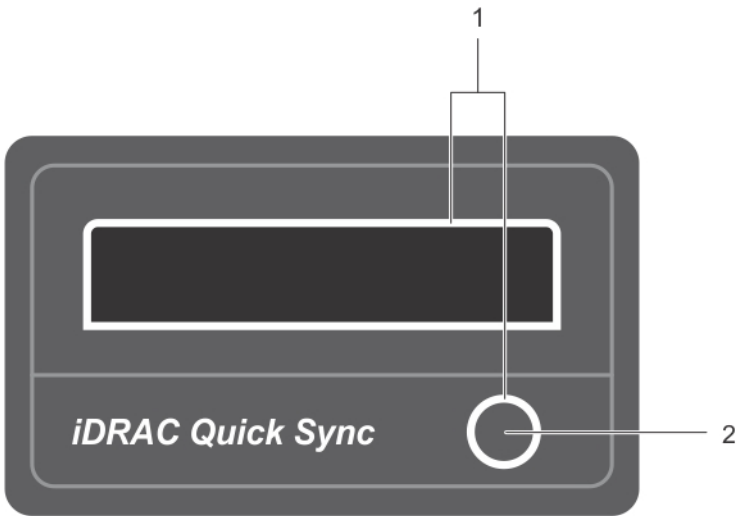

Figure 7. Quick Sync indicator codes

- | | |
|--------------------------------|---------------------------------|
| 1. Quick Sync status indicator | 2. Quick Sync activation button |
|--------------------------------|---------------------------------|

Power indicator pattern	Condition
Slow blink	Quick Sync is waiting to be configured from iDRAC.
Solid	Quick Sync is ready to transfer.
Blinks three times rapidly and then turns off	Quick Sync feature is disabled from iDRAC.
Blinks continuously when the mobile device touches the antenna	Indicates data transfer activity.
Blinks rapidly five times and turns off for one second when the activation button is pressed. This pattern is repeated until the activation button is pressed again.	Quick Sync hardware is not responding properly. Reseat the bezel. If the problem persists, see Getting help .
Off	Indicates that the Quick Sync feature is turned off. Use the activation button to activate it. If pressing the activation button does not turn on the LEDs, it indicates that power is not delivered to the Quick Sync bezel.
	NOTE: For security purposes, Quick Sync turns off after thirty seconds of in-activity after the activation button is pressed. Once timed-out, the user is expected to press the activation button again to activate Quick Sync.

Back-panel features and indicators

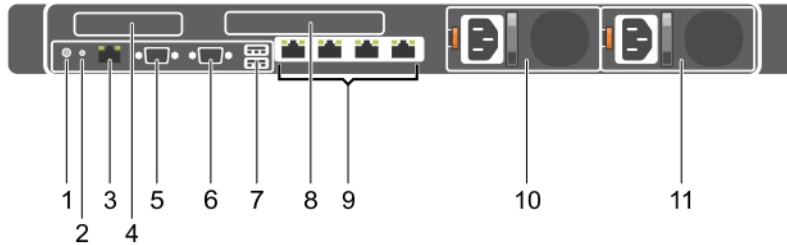









Figure 8. Back-panel features and indicators—8 hard-drive system (2 PCIe expansion cards)

Item	Indicator, Button, or Connector	Icon	Description
1	System identification button		<p>The identification buttons on the front and back panels can be used to locate a particular system within a rack. When one of these buttons is pressed, the LCD panel on the front and the system status indicator on the back blink until one of the buttons is pressed again.</p> <p>Press to toggle the system ID on and off. If the system stops responding during POST, press and hold the system ID button for more than five seconds to enter BIOS progress mode.</p> <p>To reset iDRAC (if not disabled in F2 iDRAC setup) press and hold for more than 15 seconds.</p>
2	System identification connector		Allows you to connect the optional system status indicator assembly through the optional cable management arm.
3	iDRAC8 Enterprise port		<p>Dedicated management port.</p> <p> NOTE: The port is available for use only if the iDRAC87 Enterprise license is installed on your system.</p>
4	PCIe expansion card slot (riser 1)		Allows you to connect a low profile PCIe expansion card.
5	Serial connector		Allows you to connect a serial device to the system.
6	Video connector		Allows you to connect a VGA display to the system.
7	USB connectors (2)		Allows you to connect USB devices to the system. The ports are USB 3.0-compliant.

Item	Indicator, Button, or Connector	Icon	Description
8	PCIe expansion card slot (riser 2)		Allows you to connect a full height three-fourth length PCIe expansion card.
9	Ethernet connectors (4)		Four integrated 10/100/1000 Mbps NIC connectors or Four integrated connectors: <ul style="list-style-type: none"> Two integrated 10/100/1000 Mbps NIC connectors Two integrated 100 Mbps/1 Gbps/10 Gbps SFP + connectors
10	Power supply (PSU1)		AC 495 W, 750 W, or 1100 W
11	Power supply (PSU2)		Or DC 750 W or 1100 W

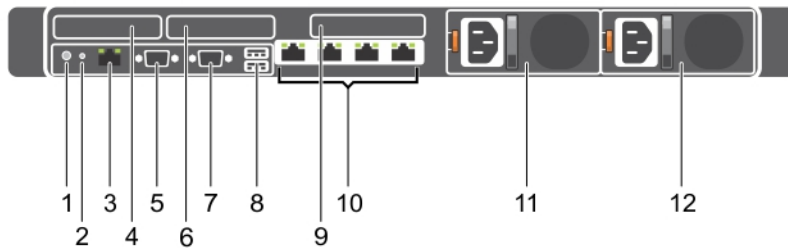









Figure 9. Back-panel features and indicators—24 hard-drive system, 10 hard-drive system, and 8 hard-drive system (3 PCIe expansion cards)

Item	Indicator, Button, or Connector	Icon	Description
1	System identification button		The identification buttons on the front and back panels can be used to locate a particular system within a rack. 10/24 Hard-Drive System When one of these buttons is pressed, the system status indicator on the back flashes until one of the buttons is pressed again. 8 Hard-Drive System When one of these buttons is pressed, the LCD panel on the front and the system status indicator on the back

Item	Indicator, Button, or Connector	Icon	Description
			flashes until one of the buttons is pressed again.
			Press to toggle the system ID on and off. If the system stops responding during POST, press and hold the system ID button for more than five seconds to enter BIOS progress mode.
			To reset iDRAC (if not disabled in F2 iDRAC setup) press and hold for more than 15 seconds.
2	System identification connector		Allows you to connect the optional system status indicator assembly through the optional cable management arm.
3	iDRAC8 Enterprise port		Dedicated management port.  NOTE: The port is available for use only if the iDRAC8 Enterprise license is installed on your system.
4	LP PCIe expansion card slot (riser 1)		Allows you to connect a low profile PCIe expansion card.
5	Serial connector		Allows you to connect a serial device to the system.
6	LP PCIe expansion card slot (riser 2)		Allows you to connect a low profile PCIe expansion card.
7	Video connector		Allows you to connect a VGA display to the system.
8	USB connectors (2)		Allows you to connect USB devices to the system. The ports are USB 3.0-compliant.
9	LP PCIe expansion card slot (riser 3)		Allows you to connect a LP PCIe expansion card.
10	Ethernet connectors (4)		Four integrated 10/100/1000 Mbps NIC connectors or Four integrated connectors: <ul style="list-style-type: none"> • Two integrated 10/100/1000 Mbps NIC connectors • Two integrated 100 Mbps/1 Gbps/10 Gbps SFP + connectors
11	Power supply (PSU1)		AC 495 W, 750 W, or 1100 W
12	Power supply (PSU2)		Or DC 750 W or 1100 W

NIC indicator codes

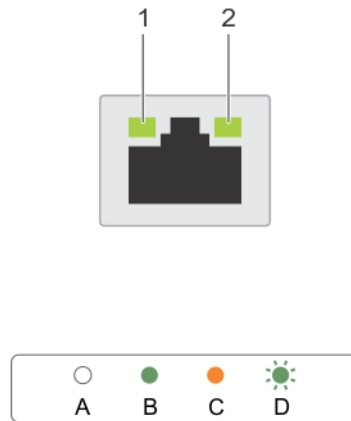

Figure 10. NIC indicators

1. link indicator
2. activity indicator

Indicator	Indicator code
Link and activity indicators are off	The NIC is not connected to the network.
Link indicator is green	The NIC is connected to a valid network at its maximum port speed (1 Gbps or 10 Gbps).
Link indicator is amber	The NIC is connected to a valid network at less than its maximum port speed.
Activity indicator is blinking green	Network data is being sent or received.

Power indicator codes

Each AC power supply unit (PSU) has an illuminated translucent handle and each DC power supply unit (when available) has an LED that serves as an indicator to show whether power is present or a power fault has occurred.



Figure 11. AC power supply unit status indicator

1. AC power supply unit status indicator/handle

Convention	Power indicator pattern	Condition
A	Green	The handle indicator lights green indicating that a valid power source is connected to the power supply unit and that the power supply unit is operational.
B	Flashing green	When updating the firmware of the power supply unit, the power supply unit handle flashes green.
C	Flashing green and turns off	When hot-adding a power supply unit (PSU), the power supply unit handle flashes green five times at 4 Hz rate and turns off. This indicates that the power supply unit is mismatched with the other power supply unit (in terms of efficiency, feature set, health status, and supported voltage). Replace the power supply unit that has the flashing indicator with a power supply unit that matches the capacity of the other installed power supply unit. <p> NOTE: For AC power supplies, use only PSUs with the Extended Power Performance (EPP) label on the back. Mixing PSUs from previous generations of servers can result in a PSU mismatch condition or failure to power on.</p>
D	Flashing amber	Indicates a problem with the power supply unit.

Convention	Power indicator pattern	Condition
		<p>△ CAUTION: When correcting a power supply unit mismatch, replace only the power supply unit with the flashing indicator. Swapping the opposite power supply unit to make a matched pair can result in an error condition and unexpected system shutdown. To change from a High Output configuration to a Low Output configuration or vice versa, you must power down the system.</p> <p>△ CAUTION: AC power supplies support both 220 V and 110 V input voltages with the exception of Titanium power supplies, which support only 220 V. When two identical power supplies receive different input voltages, they can output different wattages, and trigger a mismatch.</p> <p>△ CAUTION: If two power supplies are used, they must be of the same type and have the same maximum output power.</p> <p>△ CAUTION: Combining AC and DC power supplies is not supported and triggers a mismatch.</p>
E	Not lit	Power is not connected.

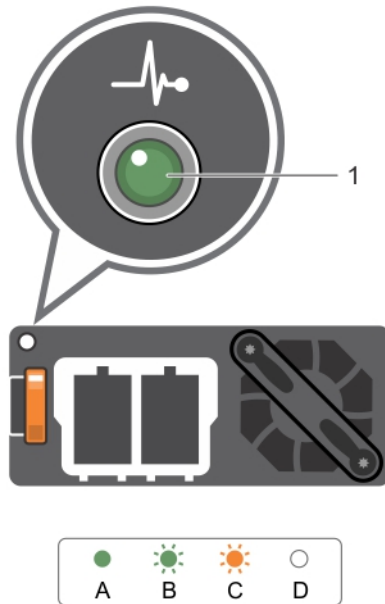





Figure 12. DC power supply unit status indicator

1. DC power supply unit status indicator

Convention	Power indicator pattern	Condition
A	Green	The handle/LED indicator lights green indicating that a valid power source is connected to the power supply unit and that the power supply unit is operational.
B	Flashing green	When hot-adding a power supply unit, power supply unit LED flashes green. This indicates that the power supply unit is mismatched with the other power supply unit (in terms of efficiency, feature set, health status, and supported voltage). Replace the power supply unit that has the flashing indicator with a power supply unit that matches the capacity of the other installed power supply unit.
C	Flashing amber	<p>Indicates a problem with the power supply unit.</p> <p> CAUTION: When correcting a power supply unit mismatch, replace only the power supply unit with the flashing indicator. Swapping the opposite power supply unit to make a matched pair can result in an error condition and unexpected system shutdown. To change from a High Output configuration to a Low Output configuration or vice versa, you must power down the system.</p> <p> CAUTION: AC power supplies support both 220 V and 110 V input voltages with the exception of Titanium power supplies, which support only 220 V. When two identical power supplies receive different input voltages, they can output different wattages, and trigger a mismatch.</p> <p> CAUTION: If two power supplies are used, they must be of the same type and have the same maximum output power.</p> <p> CAUTION: Combining AC and DC power supplies is not supported and triggers a mismatch.</p>
D	Not lit	Power is not connected.

Documentation matrix

The documentation matrix provides information on documents that you can refer to for setting up and managing your system.

To...	Refer to...
Install your system into a rack	Rack documentation included with your rack solution
Set up your system and know the system technical specifications	<i>Getting Started With Your System</i> that shipped with your system or see dell.com/poweredge/manuals
Install the operating system	Operating system documentation at dell.com/operatingsystemmanuals

To...	Refer to...
Get an overview of the Dell Systems Management offerings	Dell OpenManage Systems Management Overview Guide at dell.com/openmanagemanuals
Configure and log in to iDRAC, set up managed and management system, know the iDRAC features and troubleshoot using iDRAC	Integrated Dell Remote Access Controller User's Guide at dell.com/esmmanuals
Know about the RACADM subcommands and supported RACADM interfaces	RACADM Command Line Reference Guide for iDRAC and CMC at dell.com/esmmanuals
Launch, enable and disable Lifecycle Controller, know the features, use and troubleshoot Lifecycle Controller	Dell Lifecycle Controller User's Guide at dell.com/esmmanuals
Use Lifecycle Controller Remote Services	Dell Lifecycle Controller Remote Services Quick Start Guide at dell.com/esmmanuals
Set up, use, and troubleshoot OpenManage Server Administrator	Dell OpenManage Server Administrator User's Guide at dell.com/openmanagemanuals
Install, use and troubleshoot OpenManage Essentials	Dell OpenManage Essentials User's Guide at dell.com/openmanagemanuals
Know the features of the storage controller cards, deploy the cards, and manage the storage subsystem	Storage controller documentation at dell.com/storagecontrollermanuals
Check the event and error messages generated by the system firmware and agents that monitor system components	Dell Event and Error Messages Reference Guide at dell.com/esmmanuals

Quick Resource Locator

Use the Quick Resource Locator (QRL) to get immediate access to system information and how-to videos. This can be done by visiting dell.com/QRL or by using your smartphone or tablet and a model specific Quick Resource (QR) code located on your Dell PowerEdge system. To try out the QR code, scan the following image.



Performing initial system configuration

After you receive your PowerEdge system, you must set up your system, install the operating system, and set up and configure the system iDRAC IP address for system management.

Setting up your system

1. Unpack the server.
2. Install the server into the rack. For more information on installing the server into the rack, see your system's *Rack Installation Placemat* at dell.com/poweredgemanuals.
3. Connect any peripherals to the system.
4. Connect the system to its electrical outlet.
5. Turn the system on by pressing the power button or using iDRAC.
6. Turn on the attached peripherals.

Methods of setting up and configuring the iDRAC IP address

You can set up the Integrated Dell Remote Access Controller (iDRAC) IP address by using one of the following interfaces:

1. iDRAC Settings utility.
2. Lifecycle Controller.
3. Dell Deployment Toolkit.
4. Server LCD panel.
5. Quick Sync (optional)

You can configure iDRAC IP using:

1. iDRAC Web Interface.

For more information, see the Integrated Dell Remote Access Controller User's Guide.

2. Remote Access Controller ADMIN (RACADM).

For more information, see the RACADM Command Line Interface Reference Guide and the Integrated Dell Remote Access Controller User's Guide.

3. Remote Services that includes Web Services Management (WS-Man). For more information, see the Lifecycle Controller Remote Services Quick Start Guide.

For more information on setting up and configuring iDRAC, see the Integrated Dell Remote Access Controller User's Guide at dell.com/esmmanuals.

Information about logging in to iDRAC

You can log in to iDRAC as an iDRAC local user, as a Microsoft Active Directory user, or as a Lightweight Directory Access Protocol (LDAP) user. You can also log in using Single Sign-On or Smart Card. The default user name is **root** and password is **calvin**. For more information on logging in to iDRAC and iDRAC licenses, see the Integrated Dell Remote Access Controller User's Guide at dell.com/esmmanuals.

You can also access the iDRAC using RACADM. For more information, see the RACADM Command Line Interface Reference Guide and the Integrated Dell Remote Access Controller User's Guide available at dell.com/esmmanuals.

Methods of installing the operating system

If the server is shipped without an operating system, install the supported operating system on the server using the following methods:

- Dell Systems Management Tools and Documentation media. See the operating system documentation at dell.com/operatingsystemmanuals.
- Dell Lifecycle Controller. See the Lifecycle Controller documentation at dell.com/esmmanuals.
- Dell OpenManage Deployment Toolkit. See the OpenManage documentation at dell.com/openmanagemanuals.

For information on the list of operating systems supported on your system, see the operating systems support matrix at dell.com/ossupport.

Remote management

To perform out-of-band systems management using iDRAC, you must configure iDRAC for remote accessibility, set up the management station and managed system, and configure the supported Web browsers. For more information, see the Integrated Dell Remote Access Controller User's Guide at dell.com/esmmanuals.

You can also remotely monitor and manage the server, using the Dell OpenManage Server Administrator (OMSA) software and OpenManage Essentials (OME) systems management console. For more information, see dell.com/openmanagemanuals.

Downloading and installing drivers and firmware

It is recommended that you download and install the latest BIOS, drivers, and systems management firmware on your system.

Prerequisites

 **NOTE:** Ensure that you clear the web browser cache.

Steps

1. Go to dell.com/support/drivers.
2. In the **Product Selection** section, enter the service tag of your system in the **Service Tag or Express Service Code** field.

 **NOTE:** If you do not have the service tag, select **Automatically detect my Service Tag for me** to allow the system to automatically detect your service tag, or select **Choose from a list of all Dell products** to select your product from the **Product Selection** page.

3. Click **Get drivers and downloads**.

The drivers that are applicable to your selection are displayed.

4. Download the drivers that you require to a diskette drive, USB drive, CD, or DVD.

Pre-operating system management applications

The pre-operating system management applications for your PowerEdge system help you manage different settings and features of your system without booting to the operating system.

Your PowerEdge system has the following pre-operating system management applications:

- System Setup
- Boot Manager
- Dell Lifecycle Controller

Dell Lifecycle Controller allows you to perform useful tasks such as configuring BIOS and hardware settings, deploying operating system, updating drivers, changing RAID settings, and saving hardware profiles. For more information about Dell Lifecycle Controller, see the documentation at dell.com/esmmanuals.

Navigation keys

The navigation keys can help you access the pre-operating system management applications.

Key	Description
<PgUp>	Moves to the previous screen.
<PgDn>	Moves to the next screen.
Up arrow	Moves to the previous field.
Down arrow	Moves to the next field.
<Enter>	Enables you to type a value in the selected field (if applicable) or follow the link in the field.
Spacebar	Expands or collapses a drop-down list, if applicable.
<Tab>	Moves to the next focus area.
	 NOTE: This feature is applicable for the standard graphics browser only.
<Esc>	Moves to the previous page till you view the main screen. Pressing <Esc> in the main screen exits System BIOS/IDRAC Settings/Device Settings/Service Tag Settings and proceeds with system boot.
<F1>	Displays the System Setup help text.

About System Setup

Using System Setup, you can configure the BIOS settings, iDRAC settings, and device settings of your system.

You can access System Setup in two ways:

- Standard Graphical Browser— This is enabled by default.
- Text Browser— This is enabled using Console Redirection.

 **NOTE:** By default, help text for the selected field is displayed in the graphical browser. To view the help text in the text browser, press <F1>.

Entering System Setup

1. Turn on or restart your system.
2. Press <F2> immediately after you see the following message:
<F2> = System Setup

If your operating system begins to load before you press <F2>, allow the system to finish booting, and then restart your system and try again.

System Setup Main Menu

Option	Description
System BIOS	Enables you to configure BIOS settings.
iDRAC Settings	Enables you to configure iDRAC settings. The iDRAC Settings utility is an interface to set up and configure the iDRAC parameters using UEFI. You can enable or disable various iDRAC parameters by using the iDRAC Settings utility. For more information about this utility, see the Integrated Dell Remote Access Controller User's Guide at dell.com/esmmanuals .
Device Settings	Enables you to configure device settings.

System BIOS screen

You can use the **System BIOS** screen to view BIOS settings as well as edit specific functions such as boot order, system password, setup password, setting RAID mode, and enabling or disabling USB ports.

In the **System Setup Main Menu**, click **System BIOS**.

The **System BIOS** screen details are explained below.

Example

Menu Item	Description
System Information	Displays information about the system such as the system model name, BIOS version, Service Tag, and so on.
Memory Settings	Displays information and options related to installed memory.

Menu Item	Description
Processor Settings	Displays information and options related to the processor such as speed, cache size, and so on.
SATA Settings	Displays options to enable or disable the integrated SATA controller and ports.
Boot Settings	Displays options to specify the boot mode (BIOS or UEFI). Enables you to modify UEFI and BIOS boot settings.
Integrated Devices	Displays options to enable or disable integrated device controllers and ports, and to specify related features and options.
Serial Communication	Displays options to enable or disable the serial ports and specify related features and options.
System Profile Settings	Displays options to change the processor power management settings, memory frequency, and so on.
System Security	Displays options to configure the system security settings like, system password, setup password, TPM security, and so on. It also enables or disables support for the power and NMI buttons on the system.
Miscellaneous Settings	Displays options to change the system date, time, and so on.

System Information screen details

You can use the **System Information** screen allows to view system properties such as Service Tag, system model, and BIOS version.

You can view the **System Information** screen by clicking **System Setup Main Menu** → **System BIOS** → **System Information**.

The **System Information** screen details are explained as follows:

Example

Menu Item	Description
System Model Name	Displays the system model name.
System BIOS Version	Displays the BIOS version installed on the system.
System Management Engine Version	Displays the current revision of the Management Engine firmware.
System Service Tag	Displays the system Service Tag.
System Manufacturer	Displays the name of the system manufacturer.
System Manufacturer	Displays the contact information of the system manufacturer.

Menu Item	Description
Contact Information	
System CPLD Version	Displays the current revision of the system CPLD firmware.
UEFI Compliance Version	Displays the system firmware UEFI compliance level.



Memory Settings screen details

You can use the **Memory Settings** screen to view all the memory settings as well as to enable or disable specific memory functions such as system memory testing and node interleaving.

You can view the **Memory Setting** screen by clicking **System Setup Main Menu** → **System BIOS** → **Memory Settings**.

The **Memory Settings** screen details are explained as follows:

Example

Menu Item	Description
System Memory Size	Displays the amount of memory installed in the system.
System Memory Type	Displays the type of memory installed in the system.
System Memory Speed	Displays the system memory speed.
System Memory Voltage	Displays the system memory voltage.
Video Memory	Displays the amount of video memory.
System Memory Testing	Specifies whether system memory tests are run during system boot. Options are Enabled and Disabled . By default, the System Memory Testing option is set to Disabled .
Memory Operating Mode	Specifies the memory operating mode. The options available are Optimizer Mode , Advanced ECC Mode , Mirror Mode , Spare Mode , Spare with Advanced ECC Mode , and Dell Fault Resilient Mode . By default, the Memory Operating Mode option is set to Optimizer Mode . <ul style="list-style-type: none">  NOTE: The Memory Operating Mode can have different defaults and available options based on the memory configuration of your system.  NOTE: The Dell Fault Resilient Mode establishes an area of memory that is fault resilient. This mode can be used by an operating system that supports the feature to load critical applications or enables the operating system kernel to maximize system availability.
Node Interleaving	Specifies if Non-Uniform Memory architecture (NUMA) is supported. If this field is Enabled , memory interleaving is supported if a symmetric memory configuration is

Menu Item	Description
	installed. If Disabled , the system supports NUMA (asymmetric) memory configurations. By default, Node Interleaving option is set to Disabled .
Snoop Mode	Specifies the Snoop Mode options. Snoop Mode options available are Home Snoop , Early Snoop , Cluster on Die . By default, the Snoop Mode option is set to Early Snoop . The field is only available when Node Interleaving is Disabled .

Processor Settings screen details



You can use the **Processor Settings** screen to view the processor settings and perform specific functions such as enabling virtualization technology, hardware prefetcher, and logical processor idling.

You can view the **Processor Settings** screen by clicking **System Setup Main Menu** → **System BIOS** → **Processor Settings**.

The **Processor Settings** screen details are explained as follows:

Example

Menu Item	Description
Logical Processor	Enables or disables the logical processors and displays the number of logical processors. If the Logical Processor option is set to Enabled , the BIOS displays all the logical processors. If this option is set to Disabled , the BIOS only displays one logical processor per core. By default, the Logical Processor option is set to Enabled .
Alternate RTID (Requestor Transaction ID) Setting	Enables you to allocate more RTIDs to the remote socket, thereby increasing cache performance between the sockets or easing work in normal mode for NUMA. By default, the Alternate RTID (Requestor Transaction ID) Setting is set to Disabled .
Virtualization Technology	Enables or disables the additional hardware capabilities provided for virtualization. By default, the Virtualization Technology option is set to Enabled .
Address Translation Service (ATS)	Defines the Address Translation Cache (ATC) for devices to cache the DMA transactions. This field provides an interface to a chipset's Address Translation and Protection Table to translate DMA addresses to host addresses. By default, the option is set to Enabled .
Adjacent Cache Line Prefetch	Optimizes the system for applications that require high utilization of sequential memory access. By default, the Adjacent Cache Line Prefetch option is set to Enabled . You can disable this option for applications that require high utilization of random memory access.
Hardware Prefetcher	Enables or disables the hardware prefetcher. By default, the Hardware Prefetcher option is set to Enabled .
DCU Streamer Prefetcher	Allows you to enable or disable the Data Cache Unit (DCU) streamer prefetcher. By default, the DCU Streamer Prefetcher option is set to Enabled .
DCU IP Prefetcher	Enables or disables the Data Cache Unit (DCU) IP prefetcher. By default, the DCU IP Prefetcher option is set to Enabled .
Execute Disable	Enables or disables the execute disable memory protection technology. By default, the Execute Disable option is set to Enabled .

Menu Item	Description
Logical Processor Idling	Enables or disables the operating system capability to put logical processors in the idling state in order to reduce power consumption. By default, the option is set to Disabled .
Configurable TDP	Allows reconfiguration of Thermal Design Power (TDP) to lower levels. TDP refers to the maximum amount of power the cooling system is required to dissipate.
X2Apic Mode	Enables or disables the X2Apic mode.
Dell Controlled Turbo	 NOTE: Depending on the number of installed CPUs, there may be up to four processor listings. Controls the turbo engagement. Enable this option only when System Profile is set to Performance .
Number of Cores per Processor	Controls the number of enabled cores in each processor. By default, the Number of Cores per Processor option is set to All .
Processor 64-bit Support	Specifies if the processor(s) support 64-bit extensions.
Processor Core Speed	Displays the maximum core frequency of the processor.
Processor 1	 NOTE: Depending on the number of installed CPUs, there may be up to four processor listings. The following settings are displayed for each processor installed in the system.
Family-Model-Stepping	Displays the family, model and stepping of the processor as defined by Intel.
Brand	Displays the brand name reported by the processor.
Level 2 Cache	Displays the total L2 cache.
Level 3 Cache	Displays the total L3 cache.
Number of Cores	Displays the number of cores per processor.

SATA Settings screen details

You can use the **SATA Settings** screen to view the SATA settings of SATA devices and enable RAID on your system.

You can view the **SATA Settings** screen by clicking **System Setup Main Menu** → **System BIOS** → **SATA Settings**.

The **SATA Settings** screen details are explained below.

Example

Menu Item	Description
Embedded SATA	Enables the embedded SATA to be set to Off , ATA , AHCI , or RAID modes. By default, the Embedded SATA option is set to AHCI .
Security Freeze Lock	Sends Security Freeze Lock command to the Embedded SATA drives during POST. This option is only applicable to ATA and AHCI mode.
Write Cache	Enables or disables the command for Embedded SATA drives during POST.
Port A	Sets the drive type of the selected device. For Embedded SATA settings in ATA mode, set this field to Auto to enable BIOS support. Set it to OFF to turn off BIOS support. For AHCI mode or RAID mode, BIOS always enables support.
Model	Displays the drive model of the selected device.
Drive Type	Displays the type of drive attached to the SATA port.
Capacity	Displays the total capacity of the hard drive. The field is undefined for removable media devices such as optical drives.
Port B	Sets the drive type of the selected device. For Embedded SATA settings in ATA mode, set this field to Auto to enable BIOS support. Set it to OFF to turn off BIOS support. For AHCI mode or RAID mode, BIOS always enables support.
Model	Displays the drive model of the selected device.
Drive Type	Displays the type of drive attached to the SATA port.
Capacity	Displays the total capacity of the hard drive. The field is undefined for removable media devices such as optical drives.
Port C	Sets the drive type of the selected device. For Embedded SATA settings in ATA mode, set this field to Auto to enable BIOS support. Set it to OFF to turn off BIOS support. For AHCI mode or RAID mode, BIOS always enables support.
Model	Displays the drive model of the selected device.
Drive Type	Displays the type of drive attached to the SATA port.
Capacity	Displays the total capacity of the hard drive. The field is undefined for removable media devices such as optical drives.
Port D	Sets the drive type of the selected device. For Embedded SATA settings in ATA mode, set this field to Auto to enable BIOS support. Set it to OFF to turn off BIOS support. For AHCI mode or RAID mode, BIOS always enables support.
Model	Displays the drive model of the selected device.

Menu Item	Description
Drive Type	Displays the type of drive attached to the SATA port.
Capacity	Displays the total capacity of the hard drive. The field is undefined for removable media devices such as optical drives.
Port E	<p>Sets the drive type of the selected device. For Embedded SATA settings in ATA mode, set this field to Auto to enable BIOS support. Set it to OFF to turn off BIOS support.</p> <p>For AHCI mode or RAID mode, BIOS always enables support.</p>
Model	Displays the drive model of the selected device.
Drive Type	Displays the type of drive attached to the SATA port.
Capacity	Displays the total capacity of the hard drive. The field is undefined for removable media devices such as optical drives.
Port F	<p>Sets the drive type of the selected device. For Embedded SATA settings in ATA mode, set this field to Auto to enable BIOS support. Set it to OFF to turn off BIOS support.</p> <p>For AHCI mode or RAID mode, BIOS always enables support.</p>
Model	Displays the drive model of the selected device.
Drive Type	Displays the type of drive attached to the SATA port.
Capacity	Displays the total capacity of the hard drive. The field is undefined for removable media devices such as optical drives.
Port G	<p>Sets the drive type of the selected device. For Embedded SATA settings in ATA mode, set this field to Auto to enable BIOS support. Set it to OFF to turn off BIOS support.</p> <p>For AHCI mode or RAID mode, BIOS always enables support.</p>
Model	Displays the drive model of the selected device.
Drive Type	Displays the type of drive attached to the SATA port.
Capacity	Displays the total capacity of the hard drive. The field is undefined for removable media devices such as optical drives.
Port H	<p>Sets the drive type of the selected device. For Embedded SATA settings in ATA mode, set this field to Auto to enable BIOS support. Set it to OFF to turn off BIOS support.</p> <p>For AHCI mode or RAID mode, BIOS always enables support.</p>
Model	Displays the drive model of the selected device.
Drive Type	Displays the type of drive attached to the SATA port.
Capacity	Displays the total capacity of the hard drive. The field is undefined for removable media devices such as optical drives.

Menu Item	Description
Port I	Sets the drive type of the selected device. For Embedded SATA settings in ATA mode, set this field to Auto to enable BIOS support. Set it to OFF to turn off BIOS support. For AHCI mode or RAID mode, BIOS always enables support.
Model	Displays the drive model of the selected device.
Drive Type	Displays the type of drive attached to the SATA port.
Capacity	Displays the total capacity of the hard drive. The field is undefined for removable media devices such as optical drives.
Port J	Sets the drive type of the selected device. For Embedded SATA settings in ATA mode, set this field to Auto to enable BIOS support. Set it to OFF to turn off BIOS support. For AHCI mode or RAID mode, BIOS always enables support.
Model	Displays the drive model of the selected device.
Drive Type	Displays the type of drive attached to the SATA port.
Capacity	Displays the total capacity of the hard drive. The field is undefined for removable media devices such as optical drives.



Boot Settings screen details

You can use the **Boot Settings** screen to set the Boot mode to either **BIOS** or **UEFI**. It also allows you to specify the boot order.

You can view the **Boot Settings** screen by clicking **System Setup Main Menu** → **System BIOS** → **Boot Settings**.

The **Boot Settings** screen details are explained as follows:

Example

Menu Item	Description
Boot Mode	<p>Enables you to set the boot mode of the system.</p> <p> CAUTION: Switching the boot mode may prevent the system from booting if the operating system is not installed in the same boot mode.</p> <p> NOTE: Setting this field to UEFI disables BIOS Boot Settings menu. Setting this field to BIOS disables the UEFI Boot Settings menu.</p> <p>If the operating system supports UEFI, you can set this option to UEFI. Setting this field to BIOS allows compatibility with non-UEFI operating systems. By default, the Boot Mode option is set to BIOS.</p>
Boot Sequence Retry	Enables or disables the boot sequence retry feature. If this field is enabled and the system fails to boot, the system reattempts the boot sequence after 30 seconds. By default, the Boot Sequence Retry option is set to Enabled .
Hard Disk Failover	Specifies which devices in the Hard-Disk Drive Sequence are attempted in the boot sequence. When the option is Disabled , only the first hard disk device in the

Menu Item	Description
	list is attempted to boot. When set to Enabled , all hard disk devices are attempted in order, as listed in the Hard-Disk Drive Sequence . This option is not enabled for UEFI Boot Mode.
Boot Options Settings	Configures the boot sequence and the boot devices.

Network Settings screen details

You can use the **Network Settings** screen to modify PXE device settings. Network Settings are only available in UEFI boot mode. BIOS does not control network settings in the BIOS boot mode. For BIOS boot mode, the network settings are handled by the network controllers option ROM.

You can view the **Network Settings** screen by clicking **System Setup Main Menu** → **System BIOS** → **Network Settings**.

The **Network Settings** screen details are explained as follows:

Example

Menu Item	Description
PXE Device n (n = 1 to 4)	Enables or disables the device. When enabled, a UEFI boot option is created for the device.
PXE Device n Settings (n = 1 to 4)	Allows you to control the configuration of the PXE device.

Integrated Devices screen details

You can use the **Integrated Devices** screen to view and configure the settings of all integrated devices including the video controller, integrated RAID controller, and the USB ports.

You can view the **Integrated Devices** screen by clicking **System Setup Main Menu** → **System BIOS** → **Integrated Devices**.

The **Integrated Devices** screen details are explained below.

Example

Menu Item	Description
USB 3.0 Setting	Enables or disables the USB 3.0 support. Enable this option only if your operating system supports USB 3.0. If you disable this option, devices operate at USB 2.0 speed. USB 3.0 is disabled by default.
User Accessible USB Ports	Enables or disables the USB ports. Selecting Only Back Ports On disables the front USB ports, selecting All Ports Off disables all USB ports. The USB keyboard and mouse operates during boot process in certain operating systems. After the boot process is complete, the USB keyboard and mouse do not work if the ports are disabled.
	 NOTE: Selecting Only Back Ports On and All Ports Off will disable the USB management port and also restrict access to iDRAC features.
Internal USB Port	Enables or disables the internal USB port. By default, the option is set to Enabled .



Menu Item	Description
Integrated RAID Controller	Enables or disables the integrated RAID controller. By default, the option is set to Enabled .
Integrated Network Card 1	Enables or disables the integrated network card.
Embedded NIC1 and NIC2	 NOTE: The Embedded NIC1 and NIC2 option is only available on systems that do not have Integrated Network Card 1 . Enables or disables the Embedded NIC1 and NIC2 . If set to Disabled , the NIC may still be available for shared network access by the embedded management controller. The embedded NIC1 and NIC2 option is only available on systems that do not have NDCs. This option is mutually exclusive with the Integrated Network Card 1 option. Configure this function using the NIC management utilities of the system.
I/OAT DMA Engine	Enables or disables the I/OAT option. Enable only if the hardware and software support the feature.
Embedded Video Controller	Enables or disables the Embedded Video Controller . By default, the embedded video controller is Enabled . Current state of Embedded Video Controller is Enabled . Current State of Embedded Video Controller is a read only field, indicating the current state for the Embedded Video Controller. If the Embedded Video Controller is the only display capability in the system (that is, no add-in graphics card is installed), then the Embedded Video Controller is automatically used as the primary display even if the Embedded Video Controller setting is Disabled .
Current State of Embedded Video Controller	Displays the current state of the Embedded Video Controller . Current State of Embedded Video Controller is a read only field, indicating the current state for the Embedded Video Controller
SR-IOV Global Enable	Enables or disables the BIOS configuration of Single Root I/O Virtualization (SR-IOV) devices. By default, the SR-IOV Global Enable option is set to Disabled .
OS Watchdog Timer	If your system stops responding, this watchdog timer aids in the recovery of your operating system. When this field is set to Enabled , the operating system is allowed to initialize the timer. When the option is set to Disabled (the default), the timer will have no effect on the system.
Memory Mapped I/O above 4GB	Enables or disables the support for PCIe devices that require large amounts of memory. By default, the option is set to Enabled .
Slot Disablement	Enables or disables the available PCIe slots on your system. The Slot Disablement feature controls the configuration of PCIe cards installed in the specified slot. Slot disablement must be used only when the installed peripheral card is preventing booting into the operating system or causing delays in system startup. If the slot is disabled, both the Option ROM and UEFI driver are disabled.

Serial Communication screen details

You can use the **Serial Communication** screen to view the properties of the serial communication port. You can view the **Serial Communication** screen by clicking **System Setup Main Menu** → **System BIOS** → **Serial Communication**.

The **Serial Communication** screen details are explained below.

Example

Menu Item	Description
Serial Communication	Selects serial communication devices (Serial Device 1 and Serial Device 2) in the BIOS. BIOS console redirection can also be enabled and the port address can be specified. By default, Serial Communication option is set to Auto .
Serial Port Address	Enables you to set the port address for serial devices. By default, the Serial Port Address option is set to Serial Device 1=COM2, Serial Device 2=COM1 .  NOTE: Only Serial Device 2 can be used for Serial Over LAN (SOL). To use console redirection by SOL, configure the same port address for console redirection and the serial device.
External Serial Connector	Enables you to associate the external serial connector to serial device 1, serial device 2, or remote access device. By default, the External Serial Connector option is set to Serial Device1 .  NOTE: Only Serial Device 2 can be used for SOL. To use console redirection by SOL, configure the same port address for console redirection and the serial device.
Failsafe Baud Rate	Displays the failsafe baud rate for console redirection. The BIOS attempts to determine the baud rate automatically. This failsafe baud rate is used only if the attempt fails and the value must not be changed. By default, the Failsafe Baud Rate option is set to 115200 .
Remote Terminal Type	Sets the remote console terminal type. By default, the Remote Terminal Type option is set to VT 100/VT 220 .
Redirection After Boot	Enables or disables the BIOS console redirection when the operating system is loaded. By default, the Redirection After Boot option is set to Enabled .

System Profile Settings screen details



You can use the **System Profile Settings** screen to enable specific system performance settings such as power management.

You can view the **System Profile Settings** screen by clicking **System Setup Main Menu** → **System BIOS** → **System Profile Settings**.

The **System Profile Settings** screen details are explained as follows:

Example

Menu Item	Description
System Profile	<p>Sets the system profile. If you set the System Profile option to a mode other than Custom, the BIOS automatically sets the rest of the options. You can only change the rest of the options if the mode is set to Custom. By default, the System Profile option is set to Performance Per Watt Optimized (DAPC). DAPC is Dell Active Power Controller.</p> <p> NOTE: The following parameters are available only when the System Profile is set to Custom.</p>
CPU Power Management	<p>Sets the CPU power management. By default, the CPU Power Management option is set to System DBPM (DAPC). DBPM is Demand-Based Power Management.</p>
Memory Frequency	<p>Sets the speed of the system memory. You can select Maximum Performance, Maximum Reliability, or a specific speed.</p>
Turbo Boost	<p>Enables or disables the processor to operate in turbo boost mode. By default, the Turbo Boost option is set to Enabled.</p>
Energy Efficient Turbo	<p>Enables or disables the Energy Efficient Turbo. Energy Efficient Turbo (EET) is a mode of operation where a processor's core frequency is adjusted within the turbo range based on workload.</p>
C1E	<p>Enables or disables the processor to switch to a minimum performance state when it is idle. By default, the C1E option is set to Enabled.</p>
C States	<p>Enables or disables the processor to operate in all available power states. By default, the C States option is set to Enabled.</p>
Collaborative CPU Performance Control	<p>Enables or disables the CPU power management. When set to Enabled, the CPU power management is controlled by the OS DBPM and the System DBPM (DAPC). By default, the option is set to Disabled.</p>
Memory Patrol Scrub	<p>Sets the memory patrol scrub frequency. By default, the Memory Patrol Scrub option is set to Standard.</p>
Memory Refresh Rate	<p>Sets the memory refresh rate to either 1x or 2x. By default, the Memory Refresh Rate option is set to 1x.</p>
Uncore Frequency	<p>Selects the Processor Uncore Frequency. Dynamic mode allows the processor to optimize power resources across the cores and uncore during runtime. The optimization of the uncore frequency to either save power or optimize performance is influenced by the setting of the Energy Efficiency Policy.</p>
Energy Efficient Policy	<p>Selects the Energy Efficient Policy. The CPU uses the setting to manipulate the internal behavior of the processor and determines whether to target higher performance or better power savings.</p>

Menu Item	Description
Number of Turbo Boot Enabled Cores for Processor 1	 NOTE: If there are two processors installed in the system, you see an entry for Number of Turbo Boost Enabled Cores for Processor 2 . Controls the number of turbo boost enabled cores for processor 1. By default, the maximum number of cores is enabled.
Monitor/Mwait	Enables the Monitor/Mwait instructions in the processor. By default, the Monitor/Mwait option is set to Enabled for all system profiles, except Custom .  NOTE: This option can be disabled only if the C States option in Custom mode is disabled.  NOTE: When C States is enabled in Custom mode, changing the Monitor/Mwait setting does not impact system power/performance.



System Security settings screen details

You can use the **System Security** screen to perform specific functions such as setting the system password, setup password, and disabling the power button.

You can view the **System Security** screen by clicking **System Setup Main Menu** → **System BIOS** → **System Security Settings**.

The **System Security Settings** screen details are explained as follows:

Example

Menu Item	Description
Intel AES-NI	Improves the speed of applications by performing encryption and decryption using the Advanced Encryption Standard Instruction Set and is set to Enabled by default.
System Password	Sets the system password. This option is set to Enabled by default and is read-only if the password jumper is not installed in the system.
Setup Password	Sets the setup password. This option is read-only if the password jumper is not installed in the system.
Password Status	Locks the system password. By default, the Password Status option is set to Unlocked .
TPM Security	 NOTE: The TPM menu is available only when the TPM module is installed. Allows you to control the reporting mode of the Trusted Platform Module (TPM). By default, the TPM Security option is set to Off . You can only modify the TPM Status, TPM Activation, and Intel TXT fields if the TPM Status field is set to either On with Pre-boot Measurements or On without Pre-boot Measurements .
TPM Information	Changes the operational state of the TPM. By default, the TPM Activation option is set to No Change .
TPM Status	Displays the TPM status.
TPM Command	 CAUTION: Clearing the TPM results in the loss of all keys in the TPM. The loss of TPM keys may affect booting to the operating system.

Menu Item	Description
	Clears all the contents of the TPM. By default, the TPM Clear option is set to No .
Intel TXT	Enables or disables the Intel Trusted Execution Technology (TXT). To enable Intel TXT , Virtualization Technology must be enabled and TPM Security must be Enabled with Pre-boot measurements. By default, the Intel TXT option is set to Off .
Power Button	Enables or disables the power button on the front of the system. By default, the Power Button option is set to Enabled .
NMI Button	Enables or disables the NMI button on the front of the system. By default, the NMI Button option is set to Disabled .
AC Power Recovery	Sets how the system reacts after AC power is restored to the system. By default, the AC Power Recovery option is set to Last .
AC Power Recovery Delay	Sets how the system supports staggering of power up after AC power is restored to the system. By default, the AC Power Recovery Delay option is set to Immediate .
User Defined Delay (60s to 240s)	Sets the User Defined Delay when the User Defined option for AC Power Recovery Delay is selected.
UEFI Variable Access	Provides varying degrees of securing UEFI variables. When set to Standard (the default) UEFI variables are accessible in the Operating System per the UEFI specification. When set to Controlled , selected UEFI variables are protected in the environment and new UEFI boot entries are forced to be at the end of the current boot order.
Secure Boot	Enables Secure Boot, where the BIOS authenticates each pre-boot image using the certificates in the Secure Boot Policy. Secure Boot is disabled by default.
Secure Boot Policy	When Secure Boot policy is Standard , the BIOS uses the system manufacturer's key and certificates to authenticate pre-boot images. When Secure Boot policy is Custom , the BIOS uses the user-defined key and certificates. Secure Boot policy is Standard by default.
Secure Boot Policy Summary	Views the list of certificates and hashes that secure boot uses to authenticated images.

Secure Boot Custom Policy Settings

Secure Boot Custom Policy Settings is displayed only when **Secure Boot Policy** is set to **Custom**. In the **System Setup Main Menu**, click **System BIOS** → **System Security** → **Secure Boot Custom Policy Settings**.

The **Secure Boot Custom Policy Settings** screen details are explained as follows:

Example

Menu Item	Description
Platform Key	Imports, exports, deletes, or restores the platform key (PK).
Key Exchange Key Database	Allows you to import, export, delete, or restore entries in the Key Exchange Key (KEK) Database

Menu Item	Description
Authorized Signature Database	Imports, exports, deletes, or restores entries in the Authorized Signature Database (db).
Forbidden Signature Database	Imports, exports, deletes, or restores entries in the Forbidden Signature Database (dbx).



Miscellaneous Settings screen details

You can use the **Miscellaneous Settings** screen to perform specific functions such as updating the asset tag, and changing the system date and time.

You can view the **Miscellaneous Settings** screen by clicking **System Setup Main Menu** → **System BIOS** → **Miscellaneous Settings**.

The **Miscellaneous Settings** screen details are explained as follows:

Example

Menu Item	Description
System Time	Enables you to set the time on the system.
System Date	Enables you to set the date on the system.
Asset Tag	Displays the asset tag and enables you to modify it for security and tracking purposes.
Keyboard NumLock	Enables you to set whether the system boots with the NumLock enabled or disabled. By default the Keyboard NumLock is set to On .  NOTE: This option does not apply to 84-key keyboards.
F1/F2 Prompt on Error	Enables or disables the F1/F2 prompt on error. By default, F1/F2 Prompt on Error is set to Enabled . The F1/F2 prompt also includes keyboard errors.
Load Legacy Video Option ROM	Enables you to determine whether the system BIOS loads the legacy video (INT 10H) option ROM from the video controller. Selecting Enabled in the operating system does not support UEFI video output standards. This field is only for UEFI boot mode. You cannot set this to Enabled if UEFI Secure Boot mode is enabled.
In-System Characterization	This option enables or disables In-System Characterization . By default, In-System Characterization is set to Disabled . The two other options are Enabled and Enabled - No Reboot .  NOTE: The default setting for In-System Characterization is subject to change in future BIOS releases. When enabled, In-System Characterization (ISC) executes during POST upon detecting relevant change(s) in system configuration to optimize system power and performance. ISC takes about 20 seconds to execute, and system reset is required for ISC results to be applied. The Enabled - No Reboot option executes ISC and continues without applying ISC results until the next time system reset occurs. The Enabled option executes ISC and forces an immediate system reset so that ISC

Menu Item	Description
	results can be applied. It takes the system longer to be ready due to the forced system reset. When disabled, ISC does not execute.

About Boot Manager

Boot Manager enables you to add, delete, and arrange boot options. You can also access System Setup and boot options without restarting the system.

Entering Boot Manager

The **Boot Manager** screen allows you to select boot options and diagnostic utilities.

1. Turn on or restart your system.
2. Press <F11> when you see the message <F11> = Boot Manager.
If your operating system begins to load before you press <F11>, allow the system to finish booting, and then restart your system and try again.

Boot Manager main menu

Menu Item	Description
Continue Normal Boot	The system attempts to boot to devices starting with the first item in the boot order. If the boot attempt fails, the system continues with the next item in the boot order until the boot is successful or no more boot options are found.
One Shot Boot Menu	Takes you to the boot menu where you can select a one time boot device to boot from.
Launch System Setup	Enables you to access the System Setup.
Launch Lifecycle Controller	Exits the Boot Manager and invokes the Lifecycle Controller program.
System Utilities	Launches system utilities menu such as system diagnostics and UEFI shell.

Changing the boot order

You may have to change the boot order if you want to boot from a USB key or an optical drive.

About this task

 **NOTE:** The instructions given below may vary if you have selected **BIOS** for **Boot Mode**.

Steps

1. In the **System Setup Main Menu**, click **System BIOS** → **Boot Settings**.
2. Click **Boot Option Settings** → **Boot Sequence**.
3. Use the arrow keys to select a boot device, and use the + and - keys to move the device down or up in the ordering.
4. Click **Exit**, click **Yes** to save the settings on exit.

Choosing the system boot mode

System Setup enables you to specify the boot mode for installing your operating system:

- BIOS boot mode (the default) is the standard BIOS-level boot interface.
- UEFI boot mode is an enhanced 64-bit boot interface based on Unified Extensible Firmware Interface (UEFI) specifications that overlays the system BIOS.

You must select the boot mode in the **Boot Mode** field of the **Boot Settings** screen of System Setup. Once you specify the boot mode, the system boots in the specified boot mode and you then proceed to install your operating system from that mode. Thereafter, you must boot the system in the same boot mode (BIOS or UEFI) to access the installed operating system. Trying to boot the operating system from the other boot mode will cause the system to halt at startup.

 **NOTE:** Operating systems must be UEFI-compatible to be installed from the UEFI boot mode. DOS and 32-bit operating systems do not support UEFI and can only be installed from the BIOS boot mode.

 **NOTE:** For the latest information on supported operating systems, go to dell.com/ossupport.

Assigning a system and setup password

Prerequisites

 **NOTE:** The password jumper enables or disables the System Password and Setup Password features. For more information about the password jumper settings, see [System Board Connectors](#).

You can assign a new **System Password** and **Setup Password** or change an existing **System Password** and **Setup Password** only when the password jumper setting is **enabled** and **Password Status** is **Unlocked**.

If the password jumper setting is disabled, the existing **System Password** and **Setup Password** are deleted and you need not provide the system password to boot the system.

About this task

To assign a **System Password** and **Setup Password**, follow the steps below:

Steps

1. To enter System Setup, press <F2> immediately after a power-on or reboot.
2. From the **System Setup Main Menu**, select **System BIOS** and press <Enter>. The **System BIOS** screen is displayed.
3. On the **System BIOS** screen, select **System Security** and press <Enter>. The **System Security** screen is displayed.
4. On the **System Security** screen, verify that **Password Status** is **Unlocked**.
5. Select **System Password**, enter your system password, and press <Enter> or <Tab>. Use the following guidelines to assign the system password:
 - A password can have up to 32 characters.
 - The password can contain the numbers 0 through 9.
 - Only the following special characters are allowed: space, ("), (+), (,), (-), (.), (/), (:), (@), (\), (!), (').

A message prompts you to re-enter the system password.

6. Re-enter the system password, and click **OK**.
7. Select **Setup Password**, enter your system password and press <Enter> or <Tab>. A message prompts you to re-enter the setup password.
8. Re-enter the setup password, and click **OK**.
9. Press <Esc> to return to the System BIOS screen. Press <Esc> again. A message prompts you to save the changes.

 **NOTE:** Password protection does not take effect until the system reboots.

Deleting or changing an existing system password and setup password

Prerequisites







Ensure that the Password jumper is set to enabled and the **Password Status** is **Unlocked** before attempting to delete or change the existing System and/or Setup password. You cannot delete or change an existing System or Setup password if the **Password Status** is **Locked**.

Steps

1. To enter System Setup, press <F2> immediately after a power on or restart.
2. From the **System Setup Main Menu**, select **System BIOS** and press <Enter>. The **System BIOS** screen is displayed.
3. On the **System BIOS Screen**, select **System Security** and press <Enter>. The **System Security** screen is displayed.
4. On the **System Security** screen, verify that **Password Status** is **Unlocked**.
5. Select **System Password**, alter or delete the existing system password and press <Enter> or <Tab>.
6. Select **Setup Password**, alter or delete the existing setup password and press <Enter> or <Tab>. If you change the System and Setup password a message prompts you to re-enter the new password. If you delete the System and Setup password, a message prompts you to confirm the deletion.
7. Press <Esc> to return to the System BIOS screen. Press <Esc> again, and a message prompts you to save the changes.

Installing and removing system components

Safety instructions

-  **WARNING:** Whenever you need to lift the system, get others to assist you. To avoid injury, do not attempt to lift the system by yourself.
-  **WARNING:** Opening or removing the system cover when the system is on may expose you to a risk of electric shock.
-  **CAUTION:** Do not operate the system without the cover for a duration exceeding five minutes.
-  **CAUTION:** Many repairs may only be done by a certified service technician. You should only perform troubleshooting and simple repairs as authorized in your product documentation, or as directed by the online or telephone service and support team. Damage due to servicing that is not authorized by Dell is not covered by your warranty. Read and follow the safety instructions that came with the product.
-  **NOTE:** It is recommended that you always use a static mat and static strap while working on components inside the system.
-  **NOTE:** To ensure proper operation and cooling, all bays in the system must be populated at all times with either a module or with a blank.

Before working inside your system

1. Turn off the system, including any attached peripherals.
2. Disconnect the system from the electrical outlet and disconnect the peripherals.
3. If installed, remove the front bezel.
For more information, see [Removing the front bezel](#).
4. Remove the system cover.
For more information, see [Removing the system cover](#).

After working inside your system

1. Install the system cover.
For more information, see [Installing the system cover](#).
2. Install the optional bezel.
3. Reconnect the system to its electrical outlet and peripherals.
4. Turn the system on, including any attached peripherals.

Recommended tools

You need the following tools to perform the removal and installation procedures:

- Key to the bezel lock. This is only required when you have a bezel.
- #2 Phillips screwdriver
- #1 Phillips screwdriver
- T6, T8, T10, and T15 Torx screwdrivers

The following tools are required for assembling cables for a DC power supply unit (PSU):

- AMP 90871-1 hand-crimping tool or equivalent
- Tyco Electronics 58433-3 or equivalent
- Wire-stripper pliers capable of removing insulation from size 10 AWG solid or stranded, insulated copper wire

 **NOTE:** Use alpha wire part number 3080 or equivalent (65/30 stranding).

Front bezel (optional)

Removing the front bezel

1. Unlock the bezel lock at the left end of the bezel.
2. Lift the release latch next to the bezel lock.
3. Pull the left end of the bezel, unhook the right end and remove the bezel.

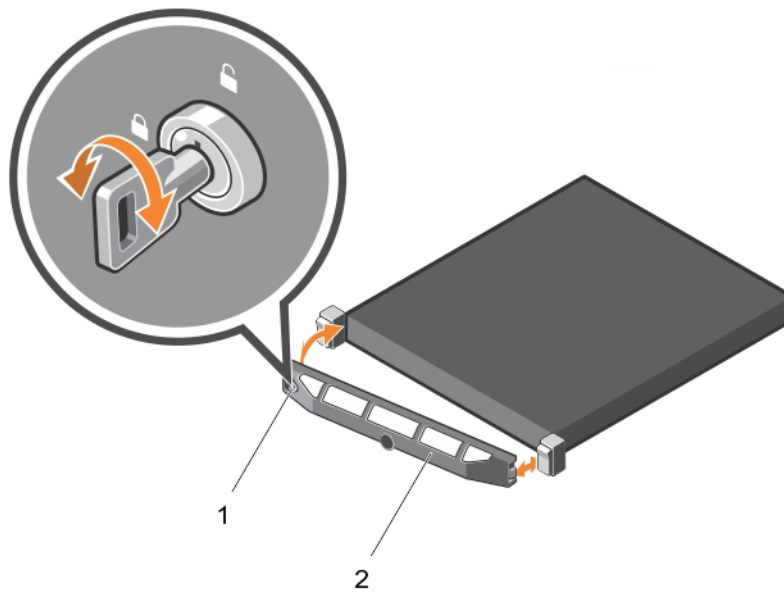

Figure 13. Removing and installing the front bezel

Installing the front bezel

1. Hook the right end of the bezel onto the chassis.
2. Fit the free end of the bezel onto the system.
3. Secure the bezel with the keylock.

Removing the system cover

Prerequisites

1. Ensure that you read the [Safety instructions](#).
2. Turn off the system, including any attached peripherals.
3. Disconnect the system from the electrical outlet and peripherals.
4. Remove the optional bezel. For more information, see [Removing the front bezel](#).

Steps

1. Turn the latch release lock to the unlock position.
2. Lift the cover release latch and remove the system cover.

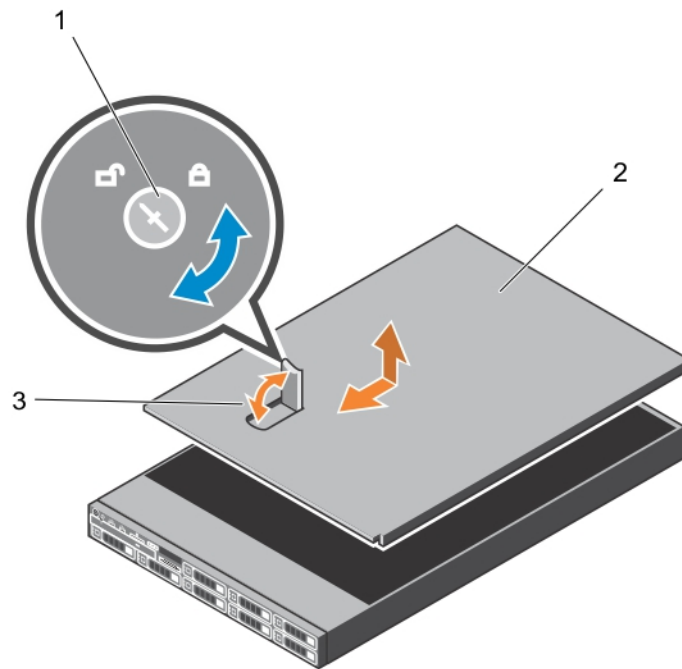

Figure 14. Removing and installing the system

1. latch release lock
2. system cover
3. latch

Installing the system cover

Prerequisites

Ensure that you read the [Safety instructions](#).

Steps

1. Align the slots of the system cover with the tabs on the chassis.
2. Press the cover release latch, and push the cover toward the front of the chassis until the latch locks into place.
3. Turn the latch release lock clockwise to the locked position.
4. Install the optional bezel.
5. Reconnect the system to its electrical outlet and turn the system on, including any attached peripherals.

Inside the system

CAUTION: Many repairs may only be done by a certified service technician. You should only perform troubleshooting and simple repairs as authorized in your product documentation, or as directed by the online or telephone service and support team. Damage due to servicing that is not authorized by Dell is not covered by your warranty. Read and follow the safety instructions that came with the product.

NOTE: Components that are hot-swappable are marked orange and touch points on the components are marked blue.

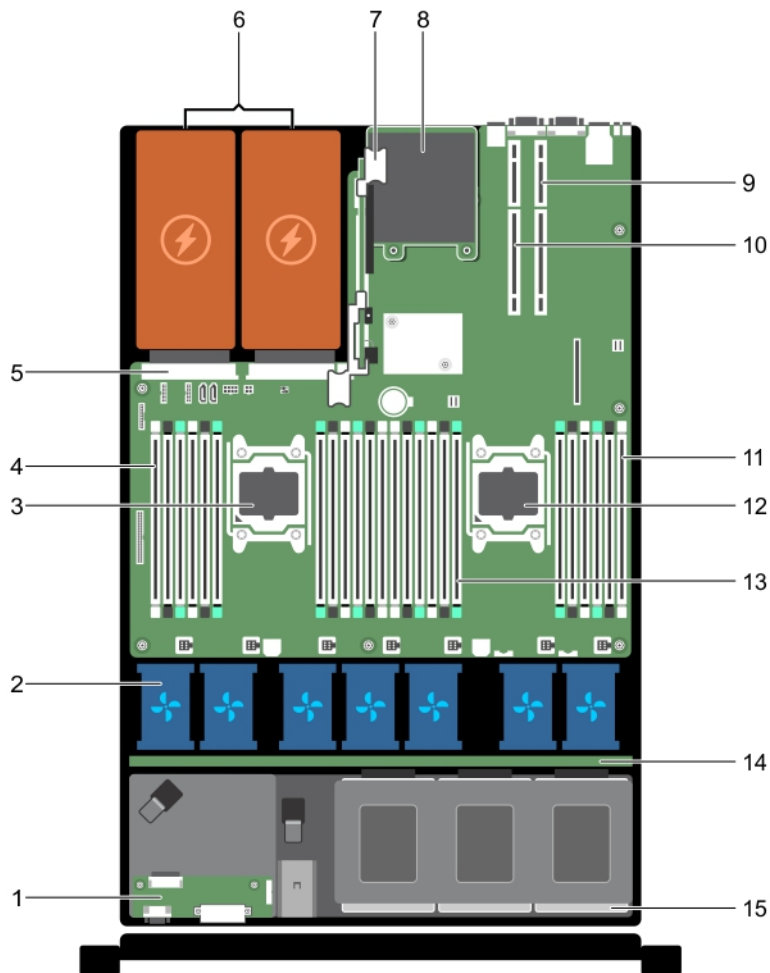

Figure 15. Inside the system—8 hard-drive system

- | | |
|---------------------------|--------------------------|
| 1. control panel assembly | 2. cooling fans (7) |
| 3. processor 1 | 4. DIMMs (6) |
| 5. PSU connector | 6. power supply (2) |
| 7. riser card 3 | 8. network daughter card |

- 9. riser card 2
- 10. riser card 1
- 11. DIMMs (6)
- 12. processor 2
- 13. DIMMs (12)
- 14. hard-drive backplane
- 15. hard drive

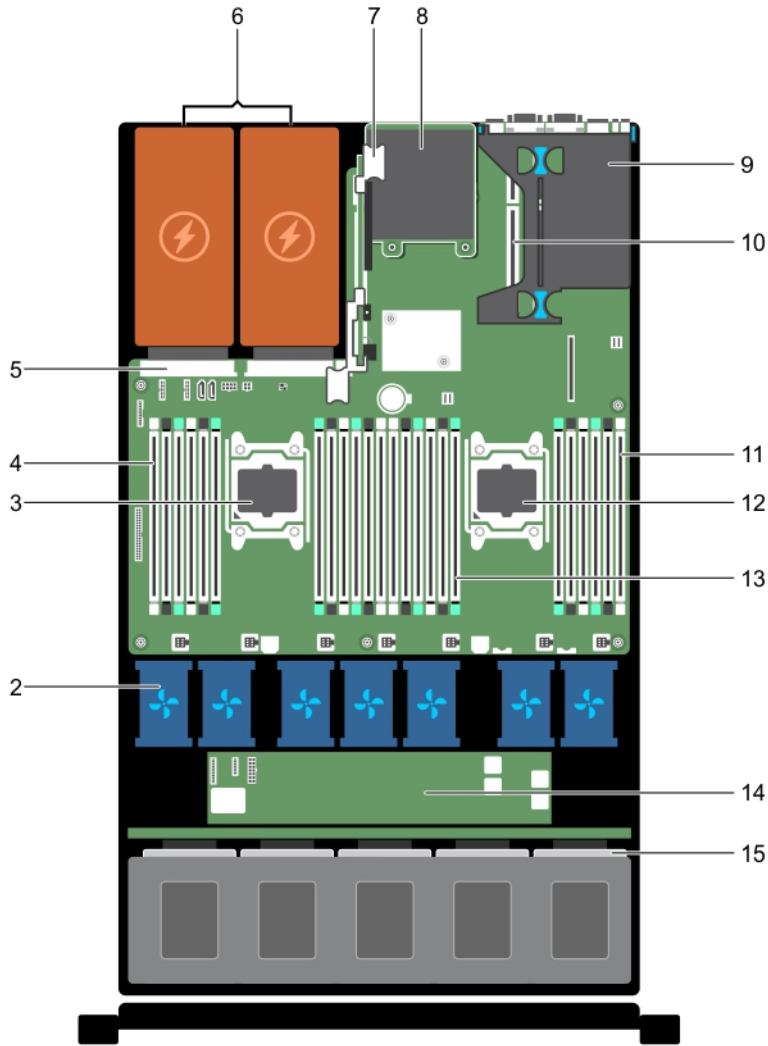

Figure 16. Inside the system—24 hard-drive system and 10 hard-drive system

- 1. control panel assembly
- 2. cooling fans (7)
- 3. processor 1
- 4. DIMMs (6)
- 5. PSU connector
- 6. power supply (2)
- 7. riser card 3
- 8. network daughter card
- 9. riser card 1
- 10. riser card 2
- 11. DIMMs (6)
- 12. processor 2
- 13. DIMMs (12)
- 14. expander board

15. hard drive

Cooling shroud

Removing the cooling shroud

Prerequisites

1. Ensure that you read the [Safety instructions](#).
2. Follow the procedure listed in [Before working inside your system](#).

△ CAUTION: Many repairs may only be done by a certified service technician. You should only perform troubleshooting and simple repairs as authorized in your product documentation, or as directed by the online or telephone service and support team. Damage due to servicing that is not authorized by Dell is not covered by your warranty. Read and follow the safety instructions that came with the product.

△ CAUTION: Never operate your system with the cooling shroud removed. The system may get overheated quickly, resulting in shutdown of the system and loss of data.

Steps

Hold the touch points and lift the shroud away from the system.

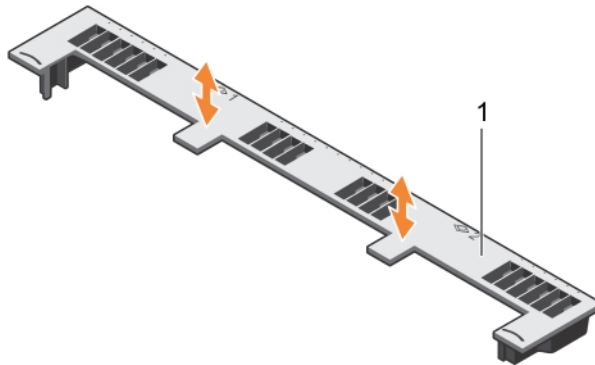

Figure 17. Removing and installing the cooling shroud

1. cooling shroud

Next steps

1. Replace the cooling shroud.
2. Follow the procedure listed in [After working inside your system](#).

Installing the cooling shroud

Prerequisites

- Ensure that you read the [Safety instructions](#).

 **CAUTION:** Many repairs may only be done by a certified service technician. You should only perform troubleshooting and simple repairs as authorized in your product documentation, or as directed by the online or telephone service and support team. Damage due to servicing that is not authorized by Dell is not covered by your warranty. Read and follow the safety instructions that came with the product.

 **NOTE:** For proper seating of the cooling shroud in the chassis, ensure that the cables inside the system are routed along the chassis wall and secured using the cable securing bracket.

Steps

1. Align the tabs on the cooling shroud with the securing slots on the chassis.
2. Lower the cooling shroud into the chassis until it is firmly seated.

Next steps

Follow the procedure listed in [After working inside your system](#).

System memory

Your system supports DDR4 registered DIMMs (RDIMMs), and load reduced DIMMs (LRDIMMs).

 **NOTE:** MT/s indicates DIMM speed in MegaTransfers per second.

Memory bus operating frequency can be 1333 MT/s, 1600 MT/s, 1866 MT/s, or 2133 MT/s depending on the following factors:

- DIMM type (RDIMM or LRDIMM)
- Number of DIMMs populated per channel
- System profile selected (for example, Performance Optimized, Custom, or Dense Configuration Optimized)
- Maximum supported DIMM frequency of the processors

The system contains 24 memory sockets split into two sets of 12 sockets, one set per processor. Each 12-socket set is organized into four channels. In each channel, the release levers of the first socket are marked white, the second socket black, and the third socket green.

 **NOTE:** DIMMs in sockets A1 to A12 are assigned to processor 1 and DIMMs in sockets B1 to B12 are assigned to processor 2.

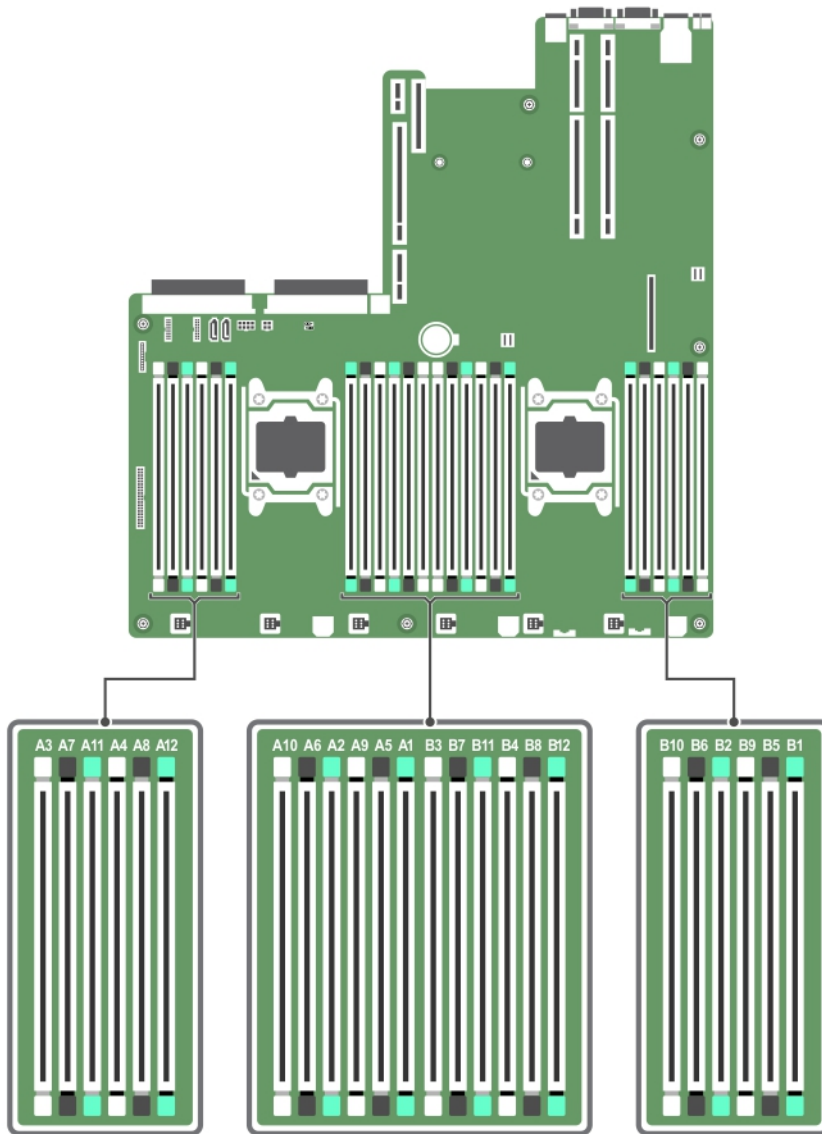

Figure 18. Memory socket locations

Memory channels are organized as follows:

- Processor 1**
- channel 0: slots A1, A5, and A9
 - channel 1: slots A2, A6, and A10
 - channel 2: slots A3, A7, and A11
 - channel 3: slots A4, A8, and A12
- Processor 2**
- channel 0: slots B1, B5, and B9
 - channel 1: slots B2, B6, and B10
 - channel 2: slots B3, B7, and B11

channel 3: slots B4, B8, and B12

The following table shows the memory populations and operating frequencies for the supported configurations.

DIMM Type	DIMMs Populated/Channel	Operating Frequency (in MT/s)	Maximum DIMM Rank/Channel
1.2 V			
RDIMM	1	2133, 1866, 1600, 1333	Dual rank or single rank
	2	2133, 1866, 1600, 1333	Dual rank or single rank
	3	1866, 1600, 1333	Dual rank or single rank
LRDIMM	1	2133, 1866, 1600, 1333	Quad rank
	2	2133, 1866, 1600, 1333	Quad rank
	3	1866, 1600, 1333	Quad rank

General memory module installation guidelines

This system supports Flexible Memory Configuration, enabling the system to be configured and run in any valid chipset architectural configuration. The following are the recommended guidelines for installing memory modules:

- RDIMMs and LRDIMMs must not be mixed.
- x4 and x8 DRAM based DIMMs can be mixed. For more information, see [Mode-specific guidelines](#).
- Up to three dual- or single-rank RDIMMs can be populated per channel.
- Up to three LRDIMMs can be populated per channel regardless of rank count.
- Populate DIMM sockets only if a processor is installed. For single-processor systems, sockets A1 to A12 are available. For dual-processor systems, sockets A1 to A12 and sockets B1 to B12 are available.
- Populate all sockets with white release tabs first, then black, and then green.
- Populate the sockets by highest rank count in the following order — first in sockets with white release levers, then black, and then green. For example, if you want to mix single-rank and dual-rank DIMMs, populate dual-rank DIMMs in the sockets with white release tabs and single-rank DIMMs in the sockets with black release tabs.
- When mixing memory modules with different capacities, populate the sockets with memory modules with highest capacity first. For example, if you want to mix 4 GB and 8 GB DIMMs, populate 8 GB DIMMs in the sockets with white release tabs and 4 GB DIMMs in the sockets with black release tabs.
- In a dual-processor configuration, the memory configuration for each processor should be identical. For example, if you populate socket A1 for processor 1, then populate socket B1 for processor 2, and so on.
- Memory modules of different capacities can be mixed provided other memory population rules are followed (for example, 4 GB and 8 GB memory modules can be mixed).
- Mixing of more than two DIMM capacities in a system is not supported.
- Populate four DIMMs per processor (one DIMM per channel) at a time to maximize performance.

Mode-specific guidelines

Four memory channels are allocated to each processor. The allowable configurations depend on the memory mode selected.

-  **NOTE:** You can mix x4 and x8 DRAM based DIMMs to support RAS features. However, all guidelines for specific RAS features must be followed. x4 DRAM based DIMMs retain Single Device Data Correction (SDDC) in memory optimized (independent channel) mode. x8 DRAM based DIMMs require Advanced ECC mode to gain SDDC.

The following sections provide additional slot population guidelines for each mode:

Advanced ECC (lockstep)

Advanced ECC mode extends SDDC from x4 DRAM based DIMMs to both x4 and x8 DRAMs. This protects against single DRAM chip failures during normal operation.

Memory installation guidelines:

- Memory modules must be identical in size, speed, and technology.
- DIMMs installed in memory sockets with white release tabs must be identical and similar rule applies for sockets with black and green release tabs. This ensures that identical DIMMs are installed in matched pairs - for example, A1 with A2, A3 with A4, A5 with A6, and so on.

-  **NOTE:** Advanced ECC with Mirroring is not supported.

Memory optimized (independent channel) mode

This mode supports SDDC only for memory modules that use x4 device width, and the mode does not impose any specific slot population requirements.

Memory sparing

-  **NOTE:** To use memory sparing, this feature must be enabled in the System Setup.

In this mode, one rank per channel is reserved as a spare. If persistent correctable errors are detected on a rank, the data from this rank is copied to the spare rank and the failed rank is disabled.

With memory sparing enabled, the system memory available to the operating system is reduced by one rank per channel. For example, in a dual-processor configuration with sixteen 4 GB dual-rank DIMMs, the available system memory is: $3/4$ (ranks/channel) \times 16 (DIMMs) \times 4 GB = 48 GB, and not 16 (DIMMs) \times 4 GB = 64 GB.

-  **NOTE:** Memory sparing does not offer protection against a multi-bit uncorrectable error.

-  **NOTE:** Both Advanced ECC/Lockstep and Optimizer modes support Memory Sparing.

Memory mirroring

Memory Mirroring offers the strongest DIMM reliability mode compared to all other modes, providing improved uncorrectable multi-bit failure protection. In a mirrored configuration, the total available system memory is one half of the total installed physical memory. Half of the installed memory is used to mirror the active DIMMs. In the event of an uncorrectable error, the system switches over to the mirrored copy. This ensures SDDC and multi-bit protection.

Memory installation guidelines:

- Memory modules must be identical in size, speed, and technology.
- DIMMs installed in memory sockets with white release levers must be identical and similar rule applies for sockets with black and green release tabs. This ensures that identical DIMMs are installed in matched pairs - for example, A1 with A2, A3 with A4, A5 with A6, and so on.

Sample memory configurations

The following tables show sample memory configurations for one and two processor configurations that follow the appropriate memory guidelines.

 **NOTE:** 1R, 2R, and 4R in the following tables indicate single-, dual-, and quad-rank DIMMs respectively.

Table 1. Memory configurations—single processor

System capacity (in GB)	DIMM size (in GB)	Number of DIMMs	DIMM rank, organization, and frequency	DIMM slot population
4	4	1	1R, x8, 2133 MT/s, 1R, x8, 1866 MT/s	A1
8	4	2	1R, x8, 2133 MT/s, 1R, x8, 1866 MT/s	A1, A2
16	4	4	1R, x8, 2133 MT/s, 1R, x8, 1866 MT/s	A1, A2, A3, A4
	8	2	2R, x8, 2133 MT/s, 2R, x8, 1866 MT/s	A1, A2
24	4	6	1R, x8, 2133 MT/s, 1R, x8, 1866 MT/s	A1, A2, A3, A4, A5, A6
48	4	12	1R, x8, 1866 MT/s, 1R, x8, 1600 MT/s	A1, A2, A3, A4, A5, A6, A7, A8, A9, A10, A11, A12
	8	6	2R, x8, 2133 MT/s, 2R, x8, 1866 MT/s	A1, A2, A3, A4, A5, A6
96	8	12	2R, x8, 1866 MT/s, 2R, x8 1600 MT/s	A1, A2, A3, A4, A5, A6, A7, A8, A9, A10, A11, A12
	16	6	2R, x4, 2133 MT/s, 2R, x4, 1866 MT/s	A1, A2, A3, A4, A5, A6
128	16	8	2R, x4, 2133 MT/s, 2R, x4, 1866 MT/s,	A1, A2, A3, A4, A5, A6, A7, A8
144	16 and 8	10	2R, x4 and 2R, x8, 1866 MT/s	A1, A2, A3, A4, A5, A6, A7, A8, A9, A11



System capacity (in GB)	DIMM size (in GB)	Number of DIMMs	DIMM rank, organization, and frequency	DIMM slot population
			2R, x4 and 2R, x8, 1600 MT/s	 NOTE: 16 GB DIMMs must be installed in slots numbered A1, A2, A3, A4, A5, A6, A7, and A8 and 8 GB DIMMs must be installed in slots A9 and A11.
384	32	12	LRDIMM, x4, 1866 MT/s LRDIMM, x4, 1600 MT/s	A1, A2, A3, A4, A5, A6, A7, A8, A9, A10, A11, A12

Table 2. Memory configurations—two processors

System capacity (in GB)	DIMM size (in GB)	Number of DIMMs	DIMM rank, organization, and frequency	DIMM slot population
16	4	4	1R, x8, 2133 MT/s, 1R, x8, 1866 MT/s	A1, A2, B1, B2
32	4	8	1R, x8, 2133 MT/s, 1R, x8, 1866 MT/s	A1, A2, A3, A4, B1, B2, B3, B4
64	4	16	1R, x8, 2133 MT/s, 1R, x8, 1866 MT/s	A1, A2, A3, A4, A5, A6, A7, A8, B1, B2, B3, B4, B5, B6, B7, B8
	8	8	2R, x8, 2133 MT/s, 2R, x8, 1866 MT/s	A1, A2, A3, A4, B1, B2, B3, B4
96	4	24	1R, x8, 1866 MT/s, 1R, x8, 1600 MT/s	A1, A2, A3, A4, A5, A6, A7, A8, A9, A10, A11, A12, B1, B2, B3, B4, B5, B6, B7, B8, B9, B10, B11, B12
	8	12	2R, x8, 2133 MT/s, 2R, x8, 1866 MT/s	A1, A2, A3, A4, A5, A6, B1, B2, B3, B4, B5, B6
128	8	16	2R, x8, 2133 MT/s, 2R, x8, 1866 MT/s	A1, A2, A3, A4, A5, A6, A7, A8, B1, B2, B3, B4, B5, B6, B7, B8
	16	8	2R, x4, 2133 MT/s, 2R, x4, 1866 MT/s	A1, A2, A3, A4, B1, B2, B3, B4

System capacity (in GB)	DIMM size (in GB)	Number of DIMMs	DIMM rank, organization, and frequency	DIMM slot population
160	8	20	2R, x8, 1866 MT/s	A1, A2, A3, A4, A5, A6, A7, A8, A9, A11, B1, B2, B3, B4, B5, B6, B7, B8, B9, B11
			2R, x8, 1600 MT/s	
	16 and 8	12	2R, x4, 2133 MT/s,	 NOTE: 16 GB DIMMs must be installed in slots numbered A1, A2, A3, A4, B1, B2, B3, and B4 and 8 GB DIMMs must be installed in slots A5, A6, B5, and B6.
			2R, x8, 2133 MT/s,	
2R, x4, 1866 MT/s				
2R, x8, 1866 MT/s				
192	8	24	2R, x8, 1866 MT/s	A1, A2, A3, A4, A5, A6, A7, A8, A9, A10, A11, A12, B1, B2, B3, B4, B5, B6, B7, B8, B9, B10, B11, B12
			2R, x8, 1600 MT/s	
	16	12	2R, x4, 2133 MT/s,	A1, A2, A3, A4, A5, A6, B1, B2, B3, B4, B5, B6
			2R, x4, 1866 MT/s	
256	16	16	2R, x4, 2133 MT/s,	A1, A2, A3, A4, A5, A6, A7, A8, B1, B2, B3, B4, B5, B6, B7, B8
			2R, x4, 1866 MT/s,	
384	16	24	2R, x4, 1866 MT/s,	A1, A2, A3, A4, A5, A6, A7, A8, A9, A10, A11, A12, B1, B2, B3, B4, B5, B6, B7, B8, B9, B10, B11, B12
			2R, x4, 1600 MT/s,	
	32	12	LRDIMM, 4R, x4, 2133 MT/s	A1, A2, A3, A4, A5, A6, B1, B2, B3, B4, B5, B6
512	32	16	LRDIMM, 4R, x4, 2133 MT/s	A1, A2, A3, A4, A5, A6, A7, A8, B1, B2, B3, B4, B5, B6, B7, B8
768	32	24	LRDIMM, 4R, x4, 1866 MT/s	A1, A2, A3, A4, A5, A6, A7, A8, A9, A10, A11, A12, B1, B2, B3, B4, B5, B6, B7, B8, B9, B10, B11, B12
			LRDIMM, 4R, x4, 1600 MT/s	

Removing memory modules

Prerequisites

 **CAUTION:** Many repairs may only be done by a certified service technician. You should only perform troubleshooting and simple repairs as authorized in your product documentation, or as directed by the online or telephone service and support team. Damage due to servicing that is not authorized by Dell is not covered by your warranty. Read and follow the safety instructions that came with the product.

1. Ensure that you read the [Safety instructions](#).
2. Follow the procedure listed in [Before working inside your system](#).
3. Remove the cooling shroud.

⚠ WARNING: The memory modules are hot to the touch for some time after the system has been powered down. Allow time for the memory modules to cool before handling them. Handle the memory modules by the card edges and avoid touching the components or metallic contacts on the memory module.

⚠ CAUTION: To ensure proper system cooling, memory-module blanks must be installed in any memory socket that is not occupied. Remove memory-module blanks only if you intend to install memory modules in those sockets.

Steps

1. Locate the appropriate memory module socket.

⚠ CAUTION: Handle each memory module only by the card edges, making sure not to touch the middle of the memory module or gold contacts.

2. To release the memory module from the socket, simultaneously press the ejectors on both ends of the memory-module socket.

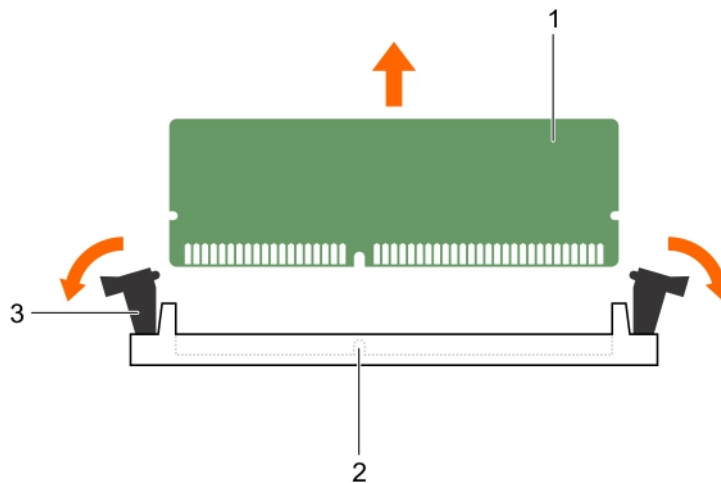



Figure 19. Removing and installing a memory module

- | | |
|-------------------------------------|-------------------------|
| 1. memory-module | 2. memory-module socket |
| 3. memory module socket ejector (2) | |

Installing memory modules

Prerequisites

 **CAUTION:** Many repairs may only be done by a certified service technician. You should only perform troubleshooting and simple repairs as authorized in your product documentation, or as directed by the online or telephone service and support team. Damage due to servicing that is not authorized by Dell is not covered by your warranty. Read and follow the safety instructions that came with the product.

1. Ensure that you read the [Safety instructions](#).
2. Follow the procedure listed in [Before working inside your system](#).
3. Remove the cooling shroud.
4. Removing the cooling-fan assembly.

 **WARNING:** The memory modules are hot to the touch for some time after the system has been powered down. Allow time for the memory modules to cool before handling them. Handle the memory modules by the card edges and avoid touching the components or metallic contacts on the memory module.

 **CAUTION:** To ensure proper system cooling, memory-module blanks must be installed in any memory socket that is not occupied. Remove memory-module blanks only if you intend to install memory modules in those sockets.

Steps

1. Locate the appropriate memory-module socket.

 **CAUTION:** Handle each memory module only by the card edges, making sure not to touch the middle of the memory module or gold contacts.

2. If a memory module or a memory-module blank is installed in the socket, remove it.

 **NOTE:** Retain the removed memory-module blank(s) for future use.

 **CAUTION:** To prevent damage to the memory module or the memory-module socket during installation, do not bend or flex the memory module; insert both ends of the memory module simultaneously.

3. Align the edge connector of the memory module with the alignment key of the memory module socket, and insert the memory module in the socket.

 **NOTE:** The memory-module socket has an alignment key that allows you to install the memory module in the socket in only one orientation.

 **CAUTION:** Do not apply pressure at the center of the memory module; apply pressure at both ends of the memory module evenly.

4. Press the memory module with your thumbs until the socket levers firmly click into place.

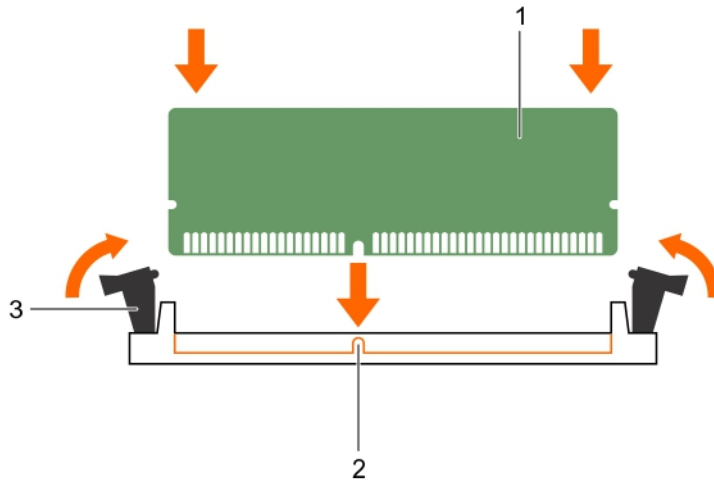

Figure 20. Installing the memory module

- | | |
|-------------------------------------|------------------|
| 1. memory module | 2. alignment key |
| 3. memory-module socket ejector (2) | |

When the memory module is properly seated in the socket, the levers on the memory module socket align with the levers on the other sockets that have memory modules installed.

- Repeat steps 4 and 5 of this procedure to install the remaining memory modules.

Next steps

- Install the cooling shroud.
- Follow the procedure listed in [After working inside your system](#).
- Press <F2> to enter System Setup, and check the **System Memory** setting. The system should have already changed the value to reflect the installed memory.
- If the value is incorrect, one or more of the memory modules may not be installed properly. Repeat step 4 through step 7 of this procedure, checking to ensure that the memory modules are firmly seated in their sockets.
- Run the system memory test in the system diagnostics.

Hard drives

All hard drives connect to the system board through the hard-drive backplane. Hard drives are supplied in hot-swappable hard-drive carriers that fit in the hard-drive slots.

CAUTION: Before attempting to remove or install a hard drive while the system is running, see the documentation for the storage controller card to ensure that the host adapter is configured correctly to support hot-swap hard drive removal and insertion.

CAUTION: Do not turn off or reboot your system while the hard drive is being formatted. Doing so can cause a hard drive failure.

 **NOTE:** Use only hard drives that have been tested and approved for use with the hard-drive backplane.

When you format a hard drive, allow enough time for the formatting to be completed. Be aware that high-capacity hard drives can take a number of hours to format.

Removing a 2.5 inch hard-drive blank

Prerequisites

 **CAUTION:** Many repairs may only be done by a certified service technician. You should only perform troubleshooting and simple repairs as authorized in your product documentation, or as directed by the online or telephone service and support team. Damage due to servicing that is not authorized by Dell is not covered by your warranty. Read and follow the safety instructions that came with the product.

 **CAUTION:** To maintain proper system cooling, all empty hard-drive slots must have hard-drive blanks installed.

1. Ensure that you read the [Safety instructions](#).
2. If installed, remove the bezel.

Steps

Press the release button and slide the hard-drive blank out of the hard-drive slot.

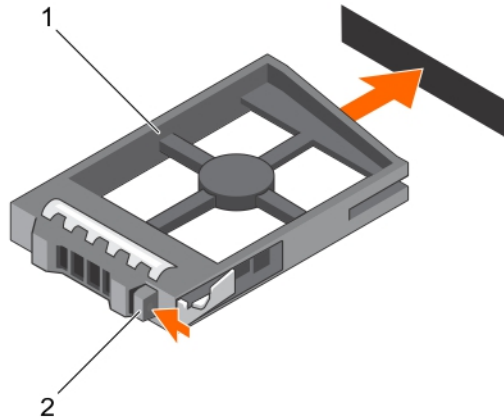

Figure 21. Removing and installing a 2.5 inch hard-drive blank

1. hard-drive blank
2. release button

Installing a 2.5 inch hard-drive blank

Prerequisites

1. Ensure that you read the [Safety instructions](#).
2. If installed, remove the front bezel.

Steps

Insert the hard-drive blank into the hard-drive slot until the release button clicks into place.

Next steps

If applicable, install the front bezel.

Removing a 1.8 inch hard-drive blank

Prerequisites

1. Ensure that you read the [Safety instructions](#).
2. If installed, remove the front bezel.

CAUTION: To maintain proper system cooling, all empty hard-drive slots must have hard-drive blanks installed.

Steps

Press the release button and slide the hard-drive blank out of the hard-drive slot.

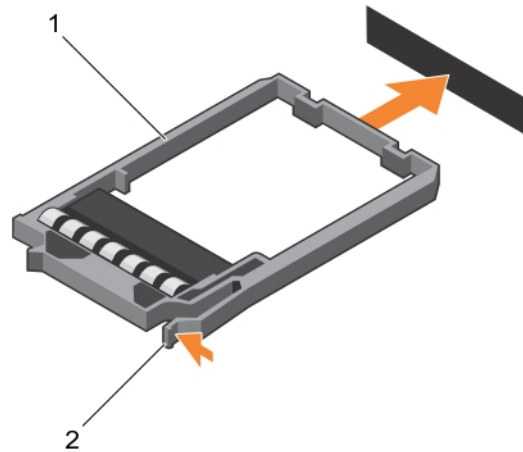

Figure 22. Removing and installing a 1.8 inch hard-drive blank

1. hard-drive blank
2. release button

Next steps

If applicable, install the front bezel.

Installing a 1.8 inch hard-drive blank

Prerequisites

1. Ensure that you read the [Safety instructions](#).
2. If installed, remove the front bezel.

Steps

Insert the hard-drive blank into the hard-drive slot until the release button clicks into place.

Next steps

If applicable, install the front bezel.

Removing a hot-swap hard drive

Prerequisites

 **CAUTION: Many repairs may only be done by a certified service technician. You should only perform troubleshooting and simple repairs as authorized in your product documentation, or as directed by the online or telephone service and support team. Damage due to servicing that is not authorized by Dell is not covered by your warranty. Read and follow the safety instructions that came with the product.**

1. Ensure that you read the [Safety instructions](#).
2. If applicable, remove the bezel.
3. Using the management software, prepare the hard drive for removal. Wait until the indicators on the hard-drive carrier signal that the hard drive can be removed safely. For more information, see the documentation for the storage controller.

If the hard drive is online, the green activity/fault indicator flashes as the drive is turned off. When the hard-drive indicators are off, the hard drive is ready for removal.

 **CAUTION: To prevent data loss, ensure that your operating system supports hot-swap drive installation. See the documentation supplied with your operating system.**

Steps

1. Press the release button to open the hard-drive carrier release handle.
2. Slide the hard-drive carrier out of the hard-drive slot.

 **CAUTION: To maintain proper system cooling, all empty hard-drive slots must have hard-drive blanks installed.**

3. If you are not replacing the hard drive immediately, insert a hard-drive blank in the empty hard-drive slot.

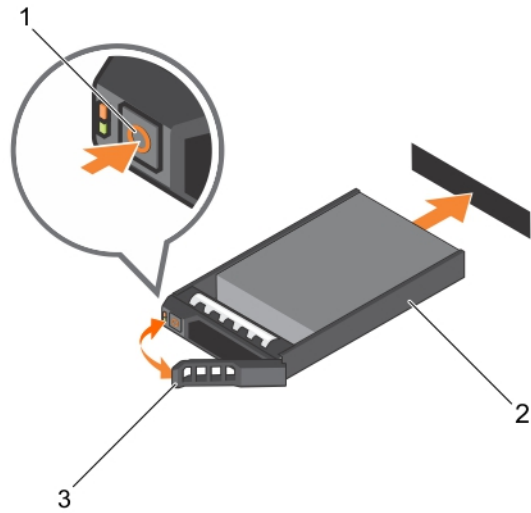

Figure 23. Removing and installing a hot-swap hard drive

- 1. release button
- 2. hard-drive carrier
- 3. hard-drive carrier handle

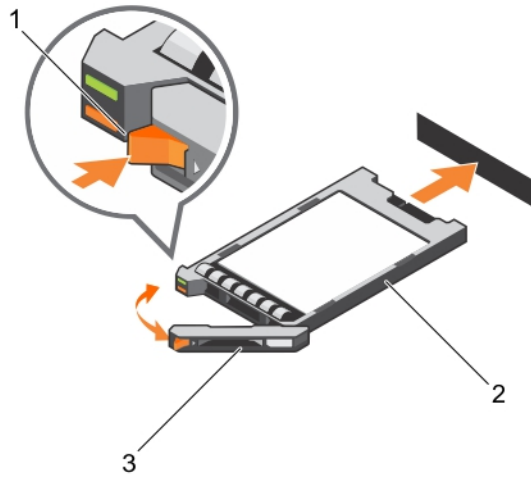



Figure 24. Removing and installing a 1.8 inch hot-swap hard drive

- 1. release button
- 2. hard-drive carrier
- 3. hard-drive carrier handle

Installing a hot-swap hard drive

Prerequisites

 **CAUTION:** Many repairs may only be done by a certified service technician. You should only perform troubleshooting and simple repairs as authorized in your product documentation, or as directed by the online or telephone service and support team. Damage due to servicing that is not authorized by Dell is not covered by your warranty. Read and follow the safety instructions that came with the product.

1. Ensure that you read the [Safety instructions](#).

 **CAUTION:** Use only hard drives that have been tested and approved for use with the hard-drive backplane.

 **CAUTION:** Combining SAS and SATA hard drives in the same RAID volume is not supported.

 **CAUTION:** When installing a hard drive, ensure that the adjacent drives are fully installed. Inserting a hard-drive carrier and attempting to lock its handle next to a partially installed carrier can damage the partially installed carrier's shield spring and make it unusable.

 **CAUTION:** To prevent data loss, ensure that your operating system supports hot-swap drive installation. See the documentation supplied with your operating system.

 **CAUTION:** When a replacement hot-swappable hard drive is installed and the system is powered on, the hard drive automatically begins to rebuild. Make absolutely sure that the replacement hard drive is blank or contains data that you wish to have over-written. Any data on the replacement hard drive is immediately lost after the hard drive is installed.

Steps

1. If a hard-drive blank is installed in the hard-drive slot, remove it.
2. Install a hard drive in the hard-drive carrier. For more information, see [Installing a hard drive into a hard-drive carrier](#).
3. Press the release button on the front of the hard-drive carrier and open the hard-drive carrier handle.
4. Insert the hard-drive carrier into the hard-drive slot until the carrier connects with the backplane.
5. Close the hard-drive carrier handle to lock the hard drive in place.

Next steps

Install the optional front bezel.

Removing a hard drive from a hard-drive carrier

Prerequisites

1. Keep the #1 Phillips screwdriver handy.
2. Remove the hard-drive carrier from the system.

Steps

1. Remove the screws from the slide rails on the hard-drive carrier.
2. Lift the hard drive out of the hard-drive carrier.

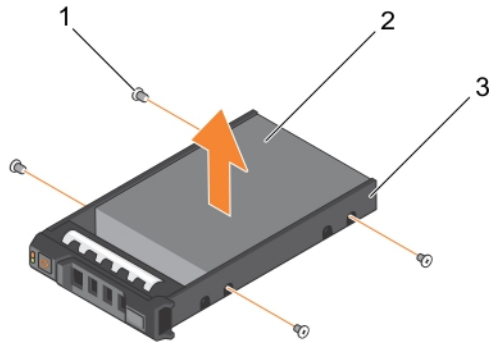

Figure 25. Removing and installing a hard drive into a hard-drive carrier

1. screw (4)
2. hard drive
3. hard-drive carrier

Installing a hard drive into a hard-drive carrier

Prerequisites

⚠ CAUTION: Many repairs may only be done by a certified service technician. You should only perform troubleshooting and simple repairs as authorized in your product documentation, or as directed by the online or telephone service and support team. Damage due to servicing that is not authorized by Dell is not covered by your warranty. Read and follow the safety instructions that came with the product.

Keep the #1 Phillips screwdriver handy.

Steps

1. Insert the hard drive into the hard-drive carrier with the connector end of the hard drive toward the back.
2. Align the screw holes on the hard drive with the set of screw holes on the hard-drive carrier. When aligned correctly, the back of the hard drive is flush with the back of the hard-drive carrier.
3. Attach the screws to secure the hard drive to the hard-drive carrier.

Removing a 1.8 inch hard drive from a hard-drive carrier

Prerequisites

1. Ensure that you read the [Safety instructions](#).
2. Remove the hard-drive carrier from the system.

Steps

1. Turn the hard-drive carrier.
2. Pull the rails of the hard-drive carrier and lift the hard drive out of the hard-drive carrier.

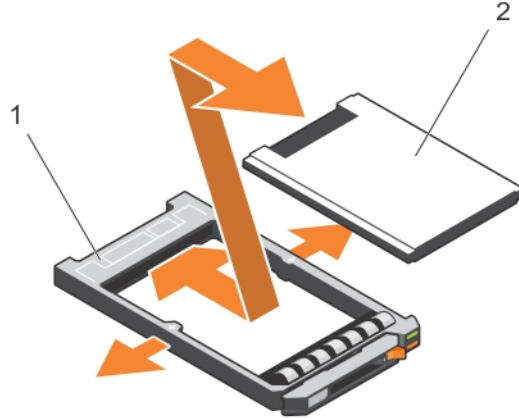

Figure 26. Removing and installing a 1.8 hard drive into a hard-drive carrier

- 1. hard drive carrier
- 2. hard-drive

Installing a 1.8 inch hard drive into a hard-drive carrier

Prerequisites

CAUTION: Many repairs may only be done by a certified service technician. You should only perform troubleshooting and simple repairs as authorized in your product documentation, or as directed by the online or telephone service and support team. Damage due to servicing that is not authorized by Dell is not covered by your warranty. Read and follow the safety instructions that came with the product.

Steps

Insert the hard drive into the hard-drive carrier with the connector end of the hard drive toward the back.

When aligned correctly, the back of the hard drive is flush with the back of the hard-drive carrier.

Optical drive (optional)

Removing the optical drive

Prerequisites

1. Ensure that you read the [Safety instructions](#).
2. Follow the procedure listed in [Before working inside your system](#).

CAUTION: Many repairs may only be done by a certified service technician. You should only perform troubleshooting and simple repairs as authorized in your product documentation, or as directed by the online or telephone service and support team. Damage due to servicing that is not authorized by Dell is not covered by your warranty. Read and follow the safety instructions that came with the product.

 **NOTE:** This procedure applies only to the 8-hard drive system.

Steps

1. Disconnect the power/data cable from the back of the drive.
Note the routing of the power/data cable on the side of the system as you remove them from the system board and drive. You must route these cables properly when you replace them to prevent them from being pinched or crimped.
2. To release the optical drive, press the release tab.
3. Slide the optical drive out of the system until it is free of the optical-drive slot.
4. If you are not adding a new optical drive, install the optical drive blank.

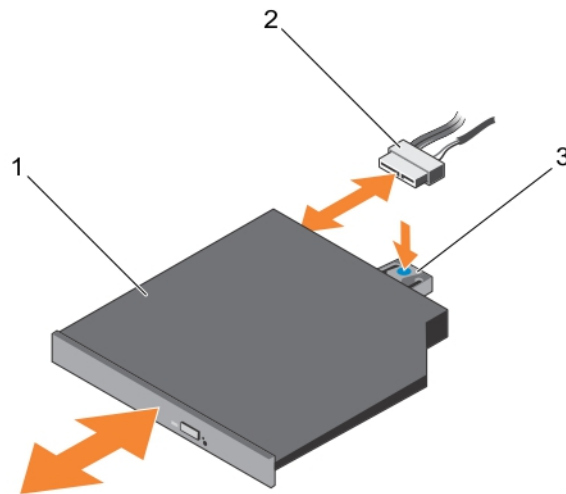

Figure 27. Removing and installing the optical drive

1. optical drive
2. power and data cable
3. release tab

Next steps

Follow the procedure listed in [After working inside your system](#).

Installing the optical drive

Prerequisites

1. Ensure that you read the [Safety instructions](#).
2. Follow the procedure listed in [Before working inside your system](#).

 **NOTE:** This procedure applies only to PowerEdge R730 systems.

 **CAUTION:** Many repairs may only be done by a certified service technician. You should only perform troubleshooting and simple repairs as authorized in your product documentation, or as directed by the online or telephone service and support team. Damage due to servicing that is not authorized by Dell is not covered by your warranty. Read and follow the safety instructions that came with the product.

 **NOTE:** This procedure applies only to the 8-hard drive system.

Steps

1. Align the optical drive with the optical drive slot on the front of the chassis.
2. Slide in the optical drive until the release tab snaps into place.
3. Connect the power/data cable to the optical drive and system board.

 **NOTE:** You must route the cable properly on the side of the system to prevent it from being pinched or crimped.

Next steps

Follow the procedure listed in [After working inside your system](#).

Removing the slim optical drive blank

Follow the same procedure to remove the slim optical drive.

Prerequisites

1. Ensure that you read the [Safety instructions](#).
2. Follow the procedure listed in [Before working inside your system](#).

 **CAUTION:** Many repairs may only be done by a certified service technician. You should only perform troubleshooting and simple repairs as authorized in your product documentation, or as directed by the online or telephone service and support team. Damage due to servicing that is not authorized by Dell is not covered by your warranty. Read and follow the safety instructions that came with the product.

Steps

1. Locate the touch point for the slim optical drive blank lock inside the system.
2. Press the lock and pull the slim optical drive blank out of the chassis.

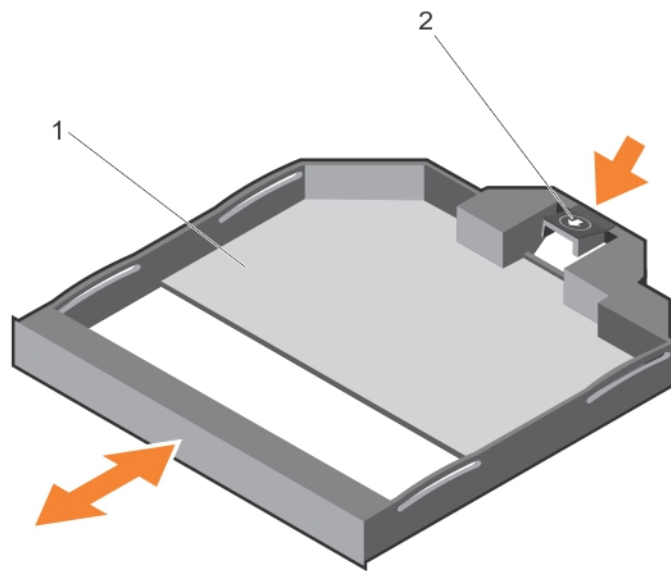

Figure 28. Removing and installing the slim optical drive blank

1. slim optical drive blank
2. optical drive blank lock

Installing the slim optical drive blank

Prerequisites

Ensure that you read the [Safety instructions](#).

⚠ CAUTION: Many repairs may only be done by a certified service technician. You should only perform troubleshooting and simple repairs as authorized in your product documentation, or as directed by the online or telephone service and support team. Damage due to servicing that is not authorized by Dell is not covered by your warranty. Read and follow the safety instructions that came with the product.

Steps

1. Align the slim optical drive blank with the slim optical drive bay.
2. Slide the optical drive blank into the optical drive bay until the lock clicks into place.

Next steps

Follow the procedure listed in [After working inside your system](#).

Cooling fans

Your system supports hot-swappable cooling fans.

✎ NOTE: In the event of a problem with a particular fan, the fan number is referenced by the system management software, allowing you to easily identify and replace the proper fan by noting the fan numbers on the cooling-fan assembly.

Removing a cooling fan

Prerequisites

1. Ensure that you read the [Safety instructions](#).
2. Follow the procedure listed in [Before working inside your system](#).

⚠ WARNING: Opening or removing the system cover when the system is ON may expose you to a risk of electric shock. Exercise utmost care while removing or installing cooling fans.

⚠ CAUTION: Many repairs may only be done by a certified service technician. You should only perform troubleshooting and simple repairs as authorized in your product documentation, or as directed by the online or telephone service and support team. Damage due to servicing that is not authorized by Dell is not covered by your warranty. Read and follow the safety instructions that came with the product.

⚠ CAUTION: The cooling fans are hot-swappable. To maintain proper cooling while the system is on, replace only one fan at a time.

⚠ CAUTION: Do not operate the system with the cover removed for a duration exceeding five minutes.

🔧 NOTE: The procedure for removing each fan is identical.

Steps

Hold the fan and lift it out of the system.

Next steps

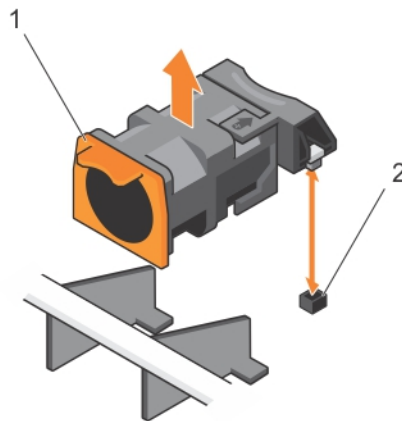



Figure 29. Removing and installing a cooling fan

1. cooling fans (7)
2. cooling fan connectors (7)

Installing a cooling fan

Prerequisites

1. Ensure that you read the [Safety instructions](#).
2. Follow the procedure listed in [Before working inside your system](#).

 **CAUTION:** Many repairs may only be done by a certified service technician. You should only perform troubleshooting and simple repairs as authorized in your product documentation, or as directed by the online or telephone service and support team. Damage due to servicing that is not authorized by Dell is not covered by your warranty. Read and follow the safety instructions that came with the product.

 **NOTE:** Your system supports seven hot-swappable cooling fans.

Steps

1. Align the plug at the base of the cooling fan with the connector on the system board.
2. Slide the cooling fan into the securing slots until the tabs lock into place.

Next steps

Follow the procedure listed in [After working inside your system](#).

Internal USB memory key (optional)

An optional USB memory key installed inside your system can be used as a boot device, security key, or mass storage device. The USB connector must be enabled by using the **Internal USB Port** option in the **Integrated Devices** screen of the System Setup menu.

To boot from the USB memory key, configure the USB memory key with a boot image and then specify the USB memory key in the boot sequence in the System Setup.

 **NOTE:** To locate the internal USB connector (J_USB_INT) on the system board, see System Board Connectors.

Replacing the internal USB key

Prerequisites

1. Ensure that you read the [Safety instructions](#).
2. Follow the procedure listed in [Before working inside your system](#).

 **CAUTION:** Many repairs may only be done by a certified service technician. You should only perform troubleshooting and simple repairs as authorized in your product documentation, or as directed by the online or telephone service and support team. Damage due to servicing that is not authorized by Dell is not covered by your warranty. Read and follow the safety instructions that came with the product.

Steps

1. Locate the USB connector or USB key on the system board.

 **NOTE:** To locate the internal USB connector on the system board, see [System board connectors](#).

2. If installed, remove the USB key.

3. Insert the new USB key into the USB connector.

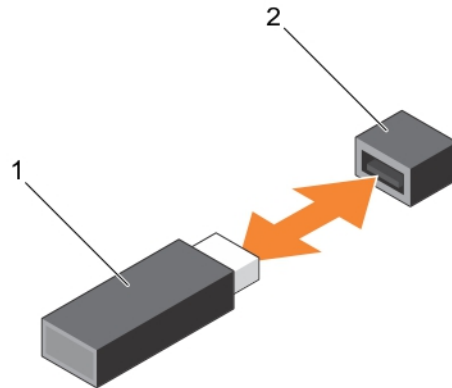

Figure 30. Replacing the internal USB key

1. USB memory key
2. USB memory key connector

Next steps

1. Follow the procedure listed in [After working inside your system](#).
2. While booting, press <F2> to enter the System Setup and verify that the USB key is detected by the system.

Expansion cards and expansion-card risers

NOTE: A missing or an unsupported expansion-card riser logs an SEL event. It does not prevent your system from powering on and no BIOS POST message or F1/F2 pause is displayed.

Expansion card installation guidelines

Your system supports PCI Express Generation 3 expansion cards.

Table 3. Systems supporting three PCIe expansion cards

Riser	PCIe Slot	Processor Connection	Height	Length	Link Width	Slot Width
1	1	Processor 2	Low Profile	Half Length	x16	x16
1	2	Processor 2	Low Profile	Half Length	x8	x16
3	3	Processor 1	Low Profile	Half Length	x16	x16

NOTE: Both the processors must be installed to use riser 1 slots.

Table 4. Systems supporting two PCIe expansion cards

Riser	PCIe Slot	Processor Connection	Height	Length	Link Width	Slot Width
2	1	Processor 1	Low Profile	Half Length	x8	x16
		Processor 2	Low Profile	Half Length	x16	x16
3	2	Processor 1	Full height	Three-fourth Length	x16	x16

 **NOTE:** Only a three-fourth length card is supported for the PCIe expansion card slot (slot 2) on riser 3.

 **NOTE:** For a server with three PCIe cards, only MiniSAS HD third party cards are supported in slot 3. For a server with two PCIe cards, only MiniSAS HD third party cards are supported in slot 1.

 **NOTE:** You can install expansion cards only on one slot on riser 2.

 **NOTE:** Both the processors must be installed to use the x16 link on the riser 2 slot.

The following table provides a guide for installing expansion cards to ensure proper cooling and mechanical fit. The expansion cards with the highest priority must be installed first using the slot priority indicated. All other expansion cards must be installed in the specified card priority and slot priority order.

Table 5. Expansion-card installation priority

Card Priority	Card Type	Systems Supporting up to 2 PCIe Expansion Cards		Systems Supporting up to 3 PCIe Expansion Cards	
		Slot Priority	Max Allowed	Slot Priority	Max Allowed
1	PCIe Bridge	N/A	N/A	1	1
2	RAID	1	1	3, 1	2
3	40 G NICs	2, 1	1	3,2	1
4	10 Gb NICs	2, 1	2	3, 2, 1	3
5	FC16 HBA	2, 1	1	3, 2, 1	1
6	FC8 HBA	2, 1	1	3, 2, 1	3
7	FC4 HBA	2, 1	1	3, 2, 1	3
8	FC16 HBA	2,1	1	N/A	N/A
9	1 Gb NICs	2, 1	1	3, 2, 1	3
10	Non-RAID	2	1	N/A	N/A
11	Integrated RAID	Integrated Slot	1	Integrated Slot	1
12	NDC	Integrated Slot	1	Integrated Slot	1

Removing an expansion card

Prerequisites

1. Ensure that you read the [Safety instructions](#).
2. Follow the procedure listed in [Before working inside your system](#).

CAUTION: Many repairs may only be done by a certified service technician. You should only perform troubleshooting and simple repairs as authorized in your product documentation, or as directed by the online or telephone service and support team. Damage due to servicing that is not authorized by Dell is not covered by your warranty. Read and follow the safety instructions that came with the product.

Steps

1. Disconnect any cables connected to the expansion card or expansion card riser.
2. To remove the expansion card, lift the expansion-card latch.
3. Grasp the expansion card by its edges and remove it from the expansion-card connector on the riser.
4. If you are removing the card permanently, install a metal filler bracket over the empty expansion slot opening and close the expansion-card latch.

NOTE: You must install a filler bracket over an empty expansion slot to maintain Federal Communications Commission (FCC) certification of the system. The brackets also keep dust and dirt out of the system and aid in proper cooling and airflow inside the system.

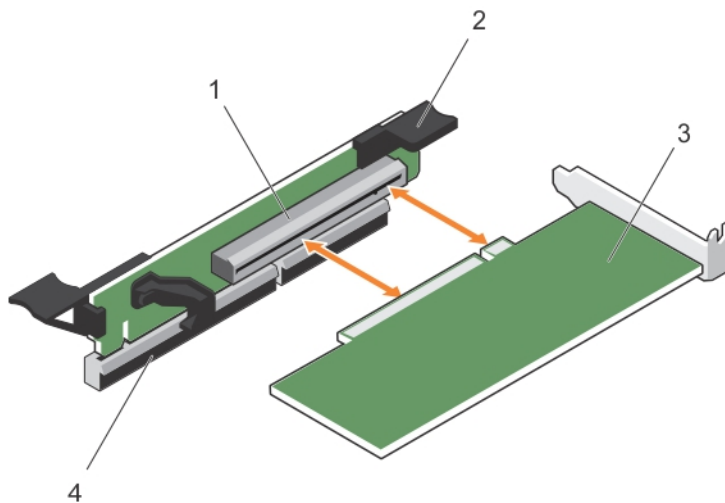

Figure 31. Removing and installing the expansion card

- | | |
|------------------------|-------------------------|
| 1. expansion connector | 2. expansion card latch |
| 3. expansion-card | 4. expansion-card latch |

Next steps

Follow the procedure listed in [After working inside your system.](#)

Installing an expansion card

Prerequisites

1. Ensure that you read the [Safety instructions.](#)
2. Follow the procedure listed in [Before working inside your system.](#)

 **CAUTION:** Many repairs may only be done by a certified service technician. You should only perform troubleshooting and simple repairs as authorized in your product documentation, or as directed by the online or telephone service and support team. Damage due to servicing that is not authorized by Dell is not covered by your warranty. Read and follow the safety instructions that came with the product.

 **NOTE:** The expansion-card riser 1 and the x16 link on the riser 2 slot can be used only when both the processors are installed.

Steps

1. Unpack the expansion card and prepare it for installation.
For instructions, see the documentation accompanying the card.
2. Locate the expansion-card connector on the system board/riser.
3. Open the expansion-card latch and remove the filler bracket.
4. Holding the card by its edges, position the card so that the card-edge connector aligns with the expansion-card connector.
5. Insert the card-edge connector firmly into the expansion-card connector until the card is fully seated.
6. Slide the expansion-card latch into position.

Next steps

1. Follow the procedure listed in [After working inside your system](#).
2. Install any device drivers required for the card as described in the documentation for the card.

Removing expansion-card risers

Prerequisites

1. Ensure that you read the [Safety instructions](#).
2. Follow the procedure listed in [Before working inside your system](#).

 **CAUTION:** Many repairs may only be done by a certified service technician. You should only perform troubleshooting and simple repairs as authorized in your product documentation, or as directed by the online or telephone service and support team. Damage due to servicing that is not authorized by Dell is not covered by your warranty. Read and follow the safety instructions that came with the product.

 **NOTE:** The expansion-card riser 1 and the x16 link on the riser 2 slot can be used only when both the processors are installed.

Steps

1. Holding the touch points, lift the expansion-card riser from the riser connector on the system board.

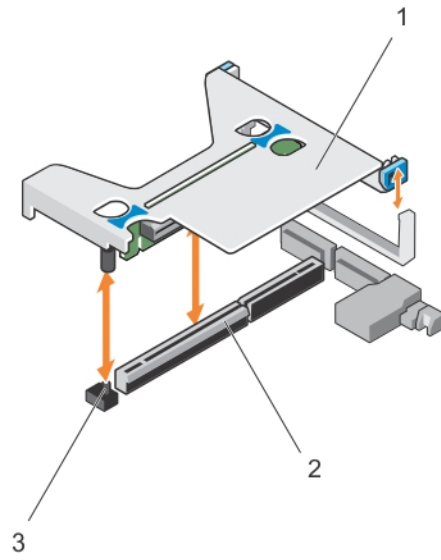

Figure 32. Removing and installing the expansion card riser 1

- 1. expansion-card riser 1
- 2. connector
- 3. riser guide pin

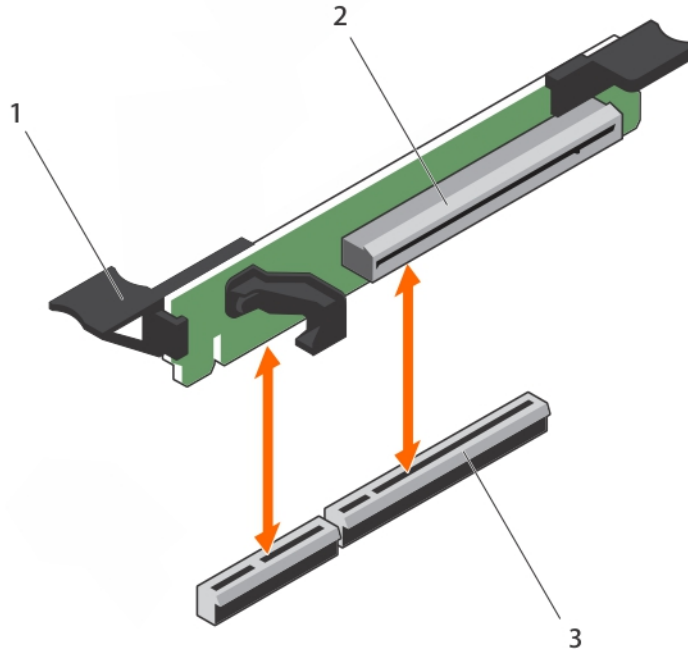

Figure 33. Removing and installing the expansion card riser 3

1. connector
2. expansion card riser 3
3. expansion card release latch

2. If applicable, remove or install an expansion card on the riser.
3. Replace the expansion-card riser.

Next steps

Follow the procedure listed in [After working inside your system](#).

Installing expansion card risers

Prerequisites

⚠ CAUTION: Many repairs may only be done by a certified service technician. You should only perform troubleshooting and simple repairs as authorized in your product documentation, or as directed by the online or telephone service and support team. Damage due to servicing that is not authorized by Dell is not covered by your warranty. Read and follow the safety instructions that came with the product.

Steps

1. If applicable, reinstall the expansion card(s) into the expansion card riser.
2. Align the expansion-card riser with the connector and the riser guide pin on the system board.
3. Lower the expansion-card riser into place until the expansion-card riser connector is fully seated in the connector.

Next steps

1. Follow the procedure listed in [After working inside your system](#).
2. Install any device drivers required for the card as described in the documentation for the card.

SD vFlash media card

A vFlash SD card is a Secure Digital (SD) card that plugs into the vFlash SD card slot in the system. It provides persistent on-demand local storage and a custom deployment environment that allows automation of server configuration, scripts, and imaging. It emulates USB device(s). For more information, see the Integrated Dell Remote Access Controller User's Guide at dell.com/esmmanuals.

Replacing a SD vFlash card

Prerequisites

 **NOTE:** This procedure applies only to the 8-hard drive system.

Steps

1. Locate the vFlash media slot on the system.
2. To remove the installed SD vFlash card, push inward on the card to release it and pull the card from the card slot.

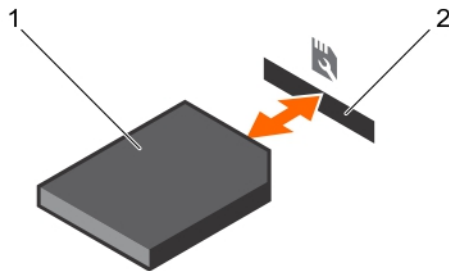



Figure 34. Removing and installing the SD vFlash card

1. SD vFlash card
2. SD vFlash card slot
3. To install the SD vFlash card, with the label side facing up, insert the contact-pin end of the SD card into the card slot on the module.

 **NOTE:** The slot is keyed to ensure correct insertion of the card.

4. Press inward on the card to lock it into the slot.

Internal dual SD module

 **NOTE:** When the **Redundancy** option is set to **Mirror Mode** in the **Integrated Devices** screen of the System Setup, the information is replicated from one SD card to another.

Removing the internal dual SD module

Prerequisites

1. Ensure that you read the [Safety instructions](#).
2. Follow the procedure listed in [Before working inside your system](#).



CAUTION: Many repairs may only be done by a certified service technician. You should only perform troubleshooting and simple repairs as authorized in your product documentation, or as directed by the online or telephone service and support team. Damage due to servicing that is not authorized by Dell is not covered by your warranty. Read and follow the safety instructions that came with the product.

Steps

1. Locate the internal dual SD module the system board.
2. If installed, remove the SD card(s).
3. Hold the plastic pull tab and pull the dual SD module out of the system board.

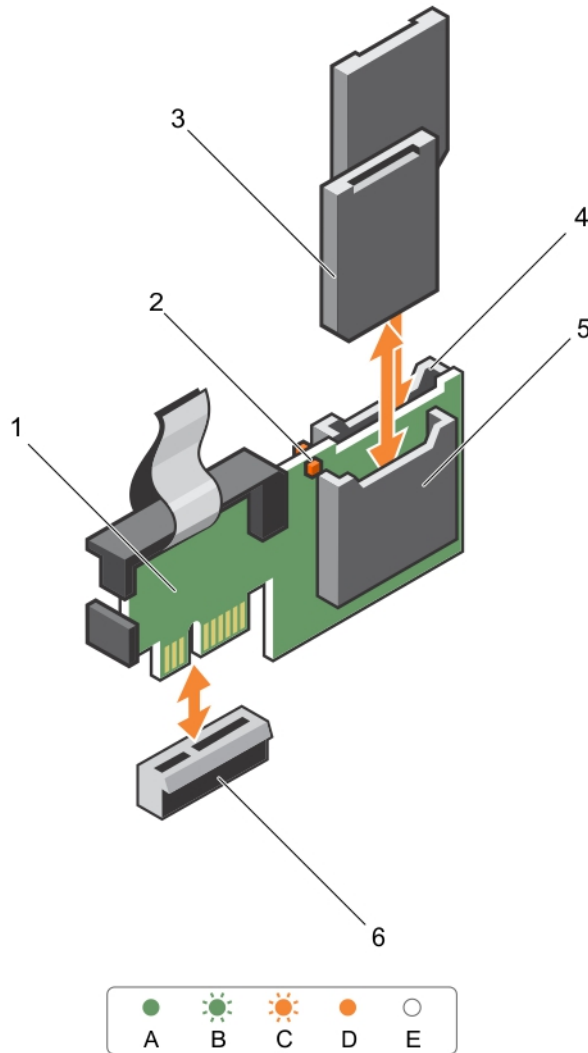

Figure 35. Removing and installing the Internal Dual SD Module (IDSDM)

- | | |
|----------------------------|-----------------------------|
| 1. Internal Dual SD module | 2. LED status indicator (2) |
| 3. SD card (2) | 4. SD card slot 2 |
| 5. SD card slot 1 | 6. IDSDM connector |

The following table describes the IDSDM indicator codes.

Convention	IDSDM indicator code	Condition
A	Green	Indicates that the card is online
B	Flashing green	Indicates rebuild or activity

Convention	IDSDM indicator code	Condition
C	Flashing amber	Indicates card mismatch or that the card has failed
D	Amber	Indicates that the card is offline, has failed, or is write protected
E	Not lit	Indicates that the card is missing or is booting

Next steps

Follow the procedure listed in [After working inside your system](#).

Installing the internal dual SD module

Prerequisites

1. Ensure that you read the [Safety instructions](#).
2. Follow the procedure listed in [Before working inside your system](#).

 **CAUTION:** Many repairs may only be done by a certified service technician. You should only perform troubleshooting and simple repairs as authorized in your product documentation, or as directed by the online or telephone service and support team. Damage due to servicing that is not authorized by Dell is not covered by your warranty. Read and follow the safety instructions that came with the product.

Steps

1. Locate the IDSDM connector on the system board.
2. Align the connectors on the system board and the dual SD module.
3. Push the dual SD module until it is firmly seated on the system board.

Next steps

1. Install the SD vFlash media card(s).
2. Follow the procedure listed in [After working inside your system](#).

Internal SD card

Removing an internal SD Card

Prerequisites

1. Ensure that you read the [Safety instructions](#).
2. Follow the procedure listed in [Before working inside your system](#).

 **CAUTION:** Many repairs may only be done by a certified service technician. You should only perform troubleshooting and simple repairs as authorized in your product documentation, or as directed by the online or telephone service and support team. Damage due to servicing that is not authorized by Dell is not covered by your warranty. Read and follow the safety instructions that came with the product.

Steps

Locate the SD card slot on the internal dual SD module or the backplane expander board and press inward on the card to release it from the slot and remove the card.

Next steps

Follow the procedure listed in [After working inside your system](#).

Installing an internal SD card

Prerequisites

1. Ensure that you read the [Safety instructions](#).
2. Follow the procedure listed in [Before working inside your system](#).



CAUTION: Many repairs may only be done by a certified service technician. You should only perform troubleshooting and simple repairs as authorized in your product documentation, or as directed by the online or telephone service and support team. Damage due to servicing that is not authorized by Dell is not covered by your warranty. Read and follow the safety instructions that came with the product.



NOTE: To use an SD card with your system, ensure that the internal SD card port is enabled in the System Setup.

Steps

1. Locate the SD card connector on the internal dual SD module or the backplane expander board. With the label side facing up, insert the contact-pin end of the card into the slot.



NOTE: The slot is keyed to ensure correct insertion of the card.

2. Press the card into the card slot to lock it into place.

Next steps

Follow the procedure listed in [After working inside your system](#).

Integrated storage controller card

Your system includes a dedicated expansion-card slot on the system board for an integrated controller card that provides the integrated storage subsystem for your system's internal hard drives. The controller supports SAS and SATA hard drives and also enables you to set up the hard drives in RAID configurations as supported by the version of the storage controller included with your system.

Removing the integrated storage controller card

Prerequisites

1. Ensure that you read the [Safety instructions](#).
2. Follow the procedure listed in [Before working inside your system](#).
3. Remove the cooling shroud.
4. Remove the expansion-card riser 1.
5. Keep the #2 Phillips screwdriver handy.

CAUTION: Many repairs may only be done by a certified service technician. You should only perform troubleshooting and simple repairs as authorized in your product documentation, or as directed by the online or telephone service and support team. Damage due to servicing that is not authorized by Dell is not covered by your warranty. Read and follow the safety instructions that came with the product.

Steps

1. Loosen the screws that secure the integrated storage controller cable to the integrated storage-controller card connector on the system board.
2. Lift the integrated storage controller cable out.
3. Lift one end of the card and angle it to disengage the card from the integrated storage-controller card holder on system board.
4. Lift the card out of the chassis.

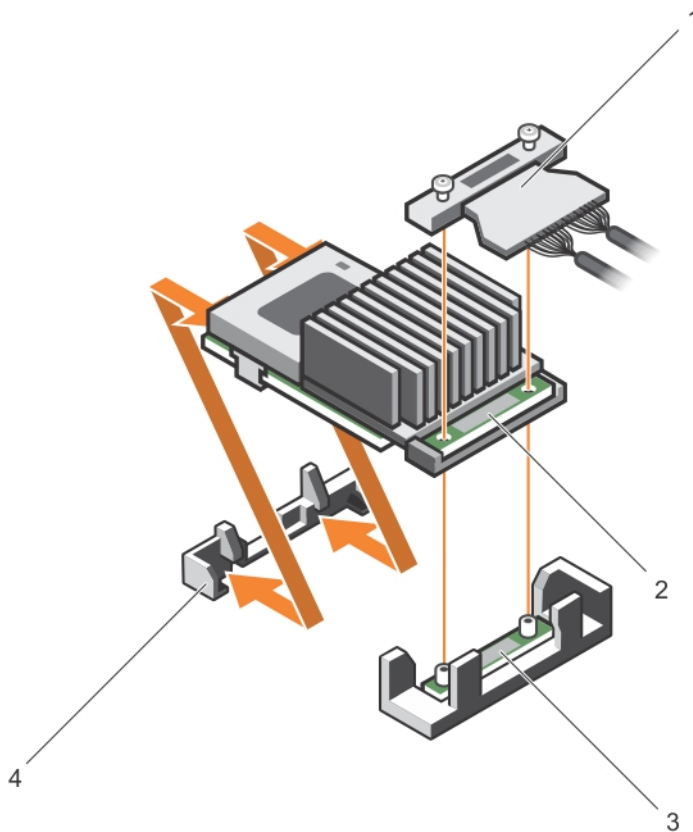

Figure 36. Removing and installing the integrated storage controller card

- | | |
|---|--|
| 1. integrated storage controller cable | 2. integrated storage controller card |
| 3. integrated storage-controller card connector on the system board | 4. integrated storage controller card holder |

Next steps

1. Replace the expansion-card riser 1.

2. Replace the cooling shroud.
3. Follow the procedure listed in [After working inside your system](#).

Installing the integrated storage controller card

Prerequisites

1. Ensure that you read the [Safety instructions](#).
2. Follow the procedure listed in [Before working inside your system](#).
3. Remove the cooling shroud.
4. Remove the expansion-card riser 1.
5. Keep the #2 Phillips screwdriver handy.

 **CAUTION:** Many repairs may only be done by a certified service technician. You should only perform troubleshooting and simple repairs as authorized in your product documentation, or as directed by the online or telephone service and support team. Damage due to servicing that is not authorized by Dell is not covered by your warranty. Read and follow the safety instructions that came with the product.

Steps

1. Align the end of the integrated storage-controller card opposite the connector with the integrated storage-controller card holder.
2. Lower the connector side of the integrated storage-controller card into the integrated storage-controller card connector on the system board.
Ensure that the tabs on the system board align with the screw holes on the integrated storage-controller card.
3. Align the screws on the integrated storage-controller card cable with the screw holes on the connector.
4. Tighten the screws to secure the integrated storage-controller card cable with the integrated storage-controller card connector on the system board.

Next steps

1. Replace the expansion-card riser 1.
2. Replace the cooling shroud.
3. Follow the procedure listed in [After working inside your system](#).

Network daughter card

 **CAUTION:** If the GPU card is installed, you cannot install the 10 GbE network daughter card.

Removing the network daughter card

Prerequisites

1. Ensure that you read the [Safety instructions](#).
2. Follow the procedure listed in [Before working inside your system](#).
3. Keep the #2 Phillips screwdriver handy.

CAUTION: Many repairs may only be done by a certified service technician. You should only perform troubleshooting and simple repairs as authorized in your product documentation, or as directed by the online or telephone service and support team. Damage due to servicing that is not authorized by Dell is not covered by your warranty. Read and follow the safety instructions that came with the product.

Steps

1. Remove the expansion-card riser 3.
2. Using a #2 Phillips screwdriver, loosen the two captive screws that secure the network daughter card to the system board.
3. Hold the network daughter card by the edges on either side of the touch points and lift to remove it from the connector on the system board.
4. Slide the network daughter card away from the back of the system until the Ethernet connectors are clear of the slot in the back panel.
5. Lift the network daughter card out of the system.

Example

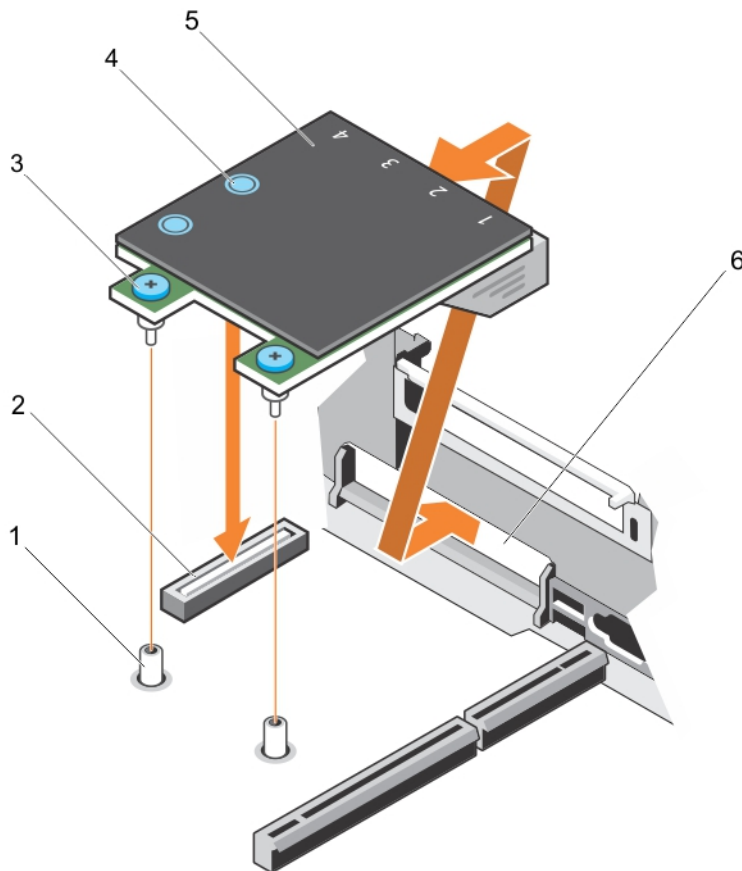

Figure 37. Removing and installing the network daughter card

1. captive screw socket (2)
2. connector on the system board

3. captive screw (2)
4. touch point (2)
5. network daughter card
6. back panel slots for Ethernet connectors

Installing the network daughter card

Prerequisites

1. Ensure that you read the [Safety instructions](#).
2. Follow the procedure listed in [Before working inside your system](#).
3. Keep the #1 Phillips screwdriver handy.



CAUTION: Many repairs may only be done by a certified service technician. You should only perform troubleshooting and simple repairs as authorized in your product documentation, or as directed by the online or telephone service and support team. Damage due to servicing that is not authorized by Dell is not covered by your warranty. Read and follow the safety instructions that came with the product.



NOTE: If the server has three PCIe cards, ensure that you install the PCIe cooling shroud in your system.

Steps

1. Angle the card so that the Ethernet connectors fit through the slot in the back panel.
2. Align the captive screws at the back-end of the card with the screw holes on the system board.
3. Press the touch point on the card to ensure that the connector on the card is in contact with the connector on the system board.
4. Using a #2 Phillips screwdriver, tighten the two captive screws to secure the network daughter card to the system board.
5. Install the expansion-card riser 3.

Next steps

Follow the procedure listed in [After working inside your system](#).

Processors

Use the following procedure when:

- Installing an additional processor
- Replacing a processor



NOTE: To ensure proper system cooling, you must install a processor blank and a heat-sink blank in any empty processor socket.

Removing a processor

Prerequisites



CAUTION: Many repairs may only be done by a certified service technician. You should only perform troubleshooting and simple repairs as authorized in your product documentation, or as directed by the online or telephone service and support team. Damage due to servicing that is not authorized by Dell is not covered by your warranty. Read and follow the safety instructions that came with the product.





NOTE: To ensure proper system cooling, you must install a processor blank in any empty processor socket.

1. Ensure that you read the [Safety instructions](#).
2. Keep the #2 Phillips screwdriver handy.
3. If you are upgrading your system, download the latest system BIOS version from dell.com/support and follow the instructions included in the compressed download file to install the update on your system.

 **NOTE:** You can update the system BIOS using the Lifecycle Controller.

4. Follow the procedure listed in [Before working inside your system](#).
5. If installed, remove the full-length PCIe card(s).
6. Remove the cooling shroud.

 **WARNING:** The heat sink and processor are hot to the touch for some time after the system has been powered down. Allow the heat sink and processor to cool before handling them.

 **CAUTION:** Never remove the heat sink from a processor unless you intend to remove the processor. The heat sink is necessary to maintain proper thermal conditions.

Steps

1. To remove the heat sink:
 - a. Loosen one of the screws that secure the heat sink to the system board.
Wait 30 seconds for the heat sink to loosen from the processor.
 - b. Remove the screw diagonally opposite the screw you first removed.
 - c. Repeat the procedure for the remaining two screws.
 - d. Remove the heat sink.

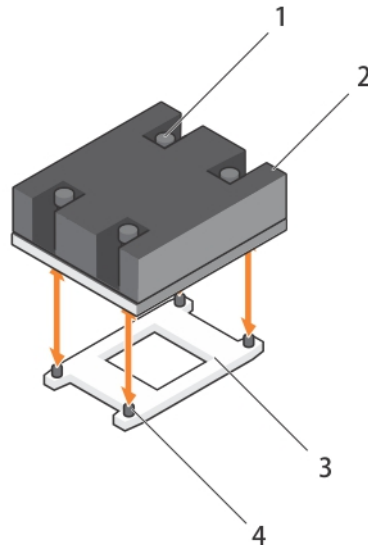

Figure 38. Removing and installing a processor heat sink

- | | |
|----------------------|--------------|
| 1. captive screw (4) | 2. heat sink |
| 3. processor socket | 4. slot (4) |

⚠ CAUTION: The processor is held in its socket under strong pressure. Be aware that the release lever can spring up suddenly if not firmly grasped.

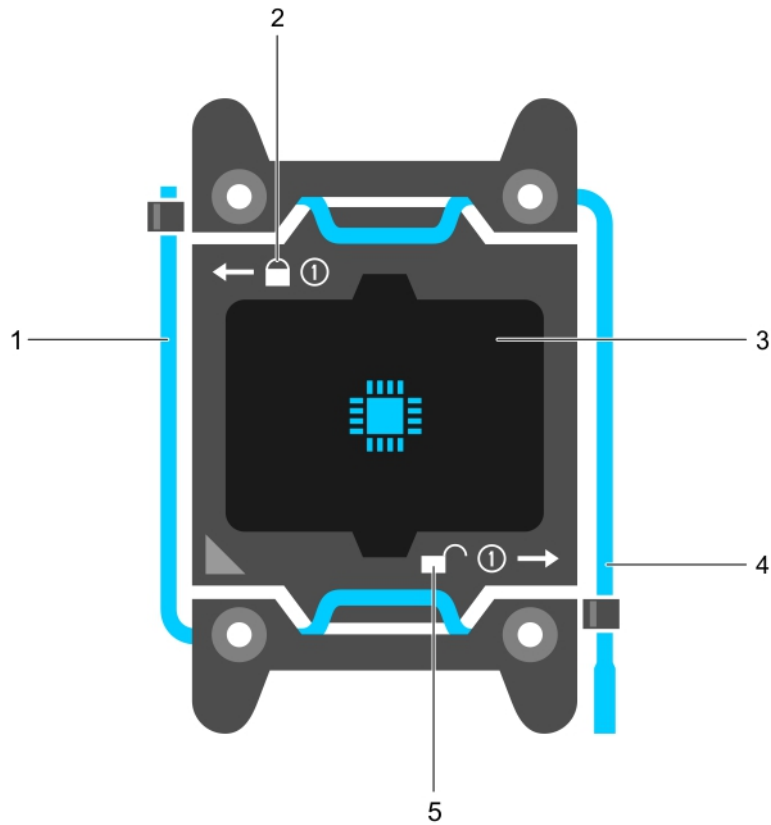



Figure 39. Processor shield

- | | |
|--|---|
| 1. <i>close first</i> socket release lever | 2. lock icon |
| 3. processor | 4. <i>open first</i> socket release lever |
| 5. unlock icon | |

2. To remove the processor:

- a. Release the *open first* socket-lever near the unlock icon  by pushing the lever down and out from under the tab.
- b. Similarly, release the *close first* socket-release lever near the lock icon  by pushing the lever down and out from under the tab. Lift the lever 90 degrees upward.
- c. Lower the *open first* socket-release lever to lift the processor shield.

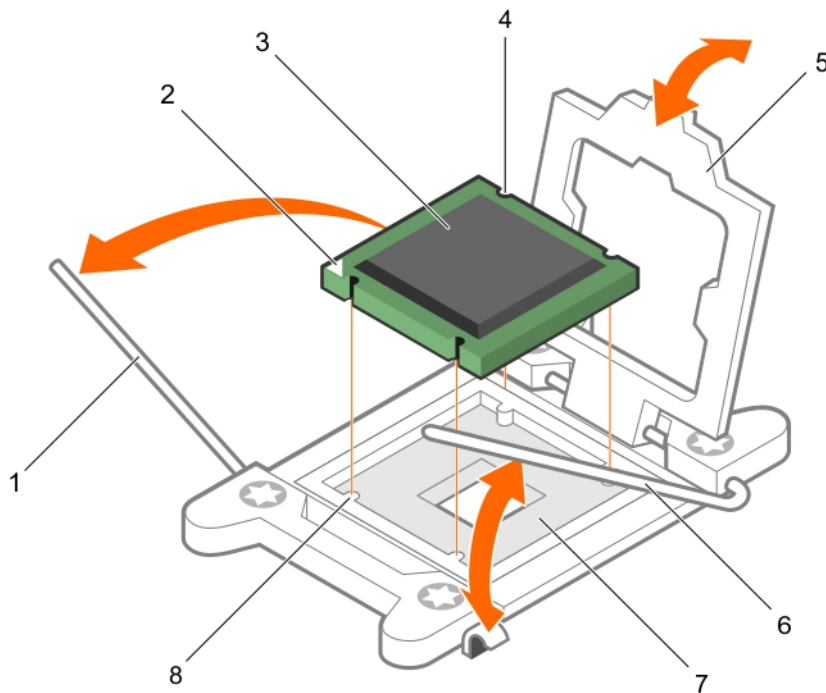

Figure 40. Removing and installing a processor

- | | |
|-------------------------------------|------------------------------------|
| 1. close first socket-release lever | 2. pin-1 indicator of processor |
| 3. processor | 4. slot (4) |
| 5. processor shield | 6. open first socket-release lever |
| 7. socket | 8. socket keys (4) |

- d. Hold the tab on the processor shield and lift the processor shield until the *open first* socket-release lever lifts up.

⚠ CAUTION: The socket pins are fragile and can be permanently damaged. Be careful not to bend the pins in the socket when removing the processor out of the socket.

- e. Lift the processor out of the socket and leave the *open first* socket-release lever up.

🔧 NOTE: If you are permanently removing the processor, you must install a socket protective cap in the vacant socket to protect the socket pins and keep the socket free of dust.

🔧 NOTE: After removing the processor, place it in an anti-static container for reuse, return, or temporary storage. Do not touch the bottom of the processor. Touch only the side edges of the processor.

Next steps

1. Replace the heat sink(s) and processor(s). See [Installing a processor](#).
2. Follow the procedure listed in [After working inside your system](#).

Installing a processor

Prerequisites

 **CAUTION:** Many repairs may only be done by a certified service technician. You should only perform troubleshooting and simple repairs as authorized in your product documentation, or as directed by the online or telephone service and support team. Damage due to servicing that is not authorized by Dell is not covered by your warranty. Read and follow the safety instructions that came with the product.

1. Ensure that you read the [Safety instructions](#).
2. Keep the #2 Phillips screwdriver handy.
3. If you are upgrading your system, download the latest system BIOS version from dell.com/support and follow the instructions included in the compressed download file to install the update on your system.

 **NOTE:** You can update the system BIOS using the Lifecycle Controller.



4. Follow the procedure listed in [Before working inside your system](#).
5. Remove the cooling shroud.

 **WARNING:** The heat sink and processor are hot to the touch for some time after the system has been powered down. Allow the heat sink and processor to cool before handling them.

 **CAUTION:** Never remove the heat sink from a processor unless you intend to remove the processor. The heat sink is necessary to maintain proper thermal conditions.

 **NOTE:** If you are installing a single processor, it must be installed in socket CPU1.

Steps

1. Remove the heat sink.
2. Unpack the new processor.
If the processor has previously been used in a system, remove any remaining thermal grease from the processor using a lint-free cloth.
3. Locate the processor socket.
4. If applicable, remove the socket protective cap.
5. Release the *open first* socket-release lever near the unlock icon  by pushing the lever down and out from under the tab.
6. Similarly, release the *close first* socket-release lever near the lock icon  by pushing the lever down and out from under the tab. Lift the lever 90 degrees upward.
7. Hold the tab near the lock symbol on the processor shield and lift it up and out of the way.
8. To install the processor in the socket:

 **CAUTION:** Positioning the processor incorrectly can permanently damage the system board or the processor. Be careful not to bend the pins in the socket.



 **CAUTION:** While removing or reinstalling the processor, wipe your hands of any contaminants. Contaminants on the processor pins such as thermal grease or oil can damage the processor.

- a. Align the processor with the socket keys.

△ CAUTION: Do not use force to seat the processor. When the processor is positioned correctly, it engages easily into the socket.

- b. Align the pin-1 indicator of the processor with the triangle on the socket .
- c. Place the processor on the socket such that the slots on the processor align with the socket keys.

△ CAUTION: Do not use force to seat the processor. When the processor is positioned correctly, it engages easily into the socket.

- d. Close the processor shield.
 - e. Lower the *close first* socket-release lever near the lock icon  and push it under the tab to lock it..
 - f. Similarly, lower the *open first* socket-release lever near the unlock icon  and push it under the tab to lock it.
9. To install the heat sink:
- a. If applicable, remove the existing thermal grease from the heat sink using a clean lint-free cloth.
 - b. Apply thermal grease on the top of the processor. Use the thermal-grease syringe included with your processor kit to apply the grease in a thin spiral on the top of the processor as shown in the figure.

△ CAUTION: Applying too much thermal grease can result in excess grease coming in contact with and contaminating the processor socket.

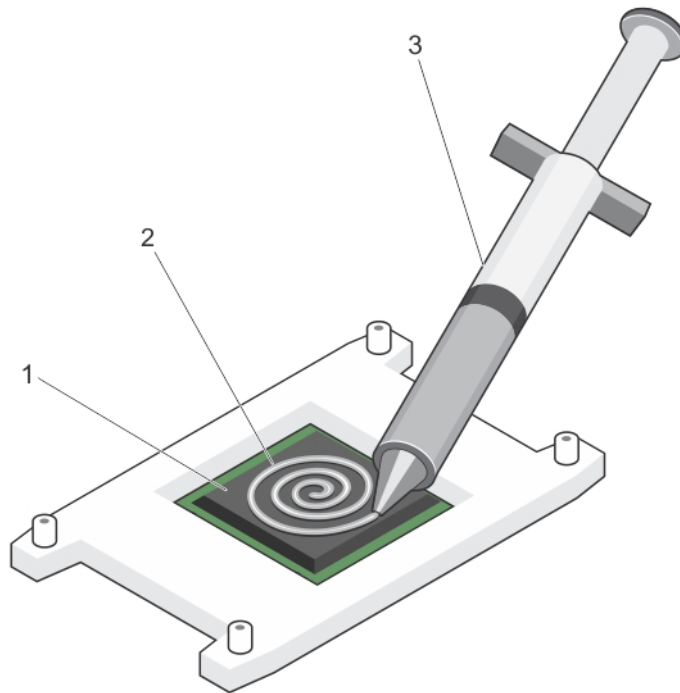



Figure 41. Applying thermal grease on the top of the processor

1. processor

2. thermal grease

3. thermal-grease syringe

 **NOTE:** The thermal-grease is intended for one-time use only. Dispose of the syringe after you use it.

- c. Place the heat sink onto the processor.
- d. Tighten the four screws to secure the heat sink to the system board.

 **NOTE:** Tighten the screws diagonally opposite to each other. Do not over-tighten the heat sink retention screws when installing the heat sink. To prevent over-tightening, tighten the retention screw until resistance is felt, and stop once the screw is seated. The screw tension should be no more than 6 in-lb (6.9 kg-cm).

Next steps

1. Install the cooling shroud.
2. Follow the procedure listed in [After working inside your system](#).
3. While booting, press <F2> to enter the System Setup and check that the processor information matches the new system configuration.
4. Run the system diagnostics to verify that the new processor operates correctly.

Power supply units

Your system supports one of the following:

- Two 495 W, 750 W, or 1100 W AC power supply modules or
- Two 1100 W DC power supply modules or
- Two 750 W mixed mode power supply modules

 **NOTE:** Titanium power supply unit is nominally rated for 200 VAC to 240 VAC input only.

 **NOTE:** When two identical power supplies are installed, power supply redundancy (1+1 – with redundancy or 2+0 – without redundancy) is configured in system BIOS. In redundant mode, power is supplied to the system equally from both power supplies when Hot Spare is disabled. When Hot Spare is enabled, one of the PSUs will be put into standby when system utilization is low in order to maximize efficiency.

 **NOTE:** If two power supply units are used, they must be of the same maximum output power.

 **NOTE:** For AC power supply units, use only power supply units with the Extended Power Performance (EPP) label on the back. Mixing power supply units from previous generations of servers can result in a power supply unit mismatch condition or failure to power on.

Hot Spare feature

Your system supports the Hot Spare feature that significantly reduces the power overhead associated with power supply redundancy.

When the Hot Spare feature is enabled, one of the redundant power supplies is switched to a sleep state. The active power supply supports 100% of the load, thus operating at higher efficiency. The power supply in the sleep state monitors output voltage of the active power supply. If the output voltage of the active power supply drops, the power supply in the sleep state returns to an active output state.

If having both power supplies active is more efficient than having one power supply in a sleep state, the active power supply can also activate a sleeping power supply.

The default power supply settings are as follows:

- If the load on the active power supply is more than 50%, then the redundant power supply is switched to the active state.
- If the load on the active power supply falls below 20%, then the redundant power supply is switched to the sleep state

You can configure the Hot Spare feature using the iDRAC settings. For more information on iDRAC settings, see the Integrated Dell Remote Access Controller User's Guide at dell.com/support/manuals.

Removing the power supply unit blank

If you are installing a second power supply unit, remove the power supply unit blank in the bay by pulling the blank outward.

 **CAUTION: To ensure proper system cooling, the power supply blank must be installed in the second power supply bay in a non-redundant configuration. Remove the power supply blank only if you are installing a second power supply.**

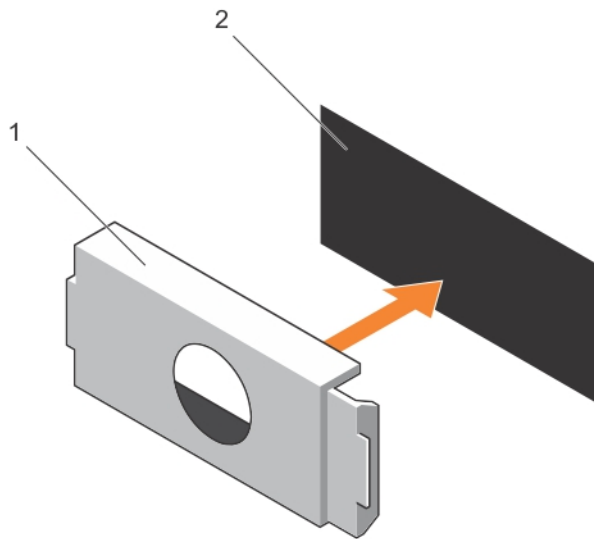

Figure 42. Removing and installing the power supply blank

1. power supply blank
2. power supply bay

Installing the power supply unit blank

Install the power supply unit blank only in the second power supply unit bay.

To install the power supply unit blank, align the blank with the power supply unit bay and push it into the chassis until it clicks into place.

Removing an AC power supply unit

Prerequisites

⚠ CAUTION: Many repairs may only be done by a certified service technician. You should only perform troubleshooting and simple repairs as authorized in your product documentation, or as directed by the online or telephone service and support team. Damage due to servicing that is not authorized by Dell is not covered by your warranty. Read and follow the safety instructions that came with the product.

⚠ CAUTION: The system requires one power supply for normal operation. On power-redundant systems, remove and replace only one power supply at a time in a system that is powered on.

🔧 NOTE: You may have to unlatch and lift the optional cable management arm if it interferes with power supply removal. For information about the cable management arm, see the system's rack documentation.

Steps

1. Disconnect the power cable from the power source and from the power supply unit you intend to remove and remove the cables from the strap.
2. Press the release latch and slide the power supply unit out of the chassis.

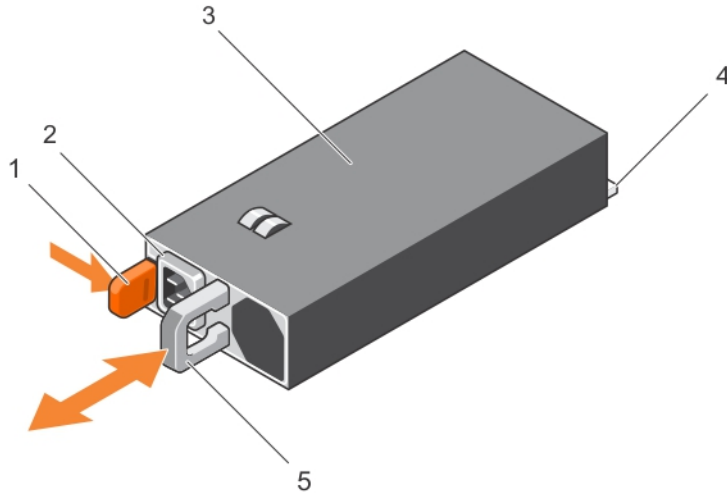

Figure 43. Removing and installing an AC power supply unit

- | | |
|-----------------------------|--------------------------------------|
| 1. release latch | 2. power supply unit cable connector |
| 3. power supply unit | 4. connector |
| 5. power supply unit handle | |

Installing an AC power supply unit

Prerequisites

⚠ CAUTION: Many repairs may only be done by a certified service technician. You should only perform troubleshooting and simple repairs as authorized in your product documentation, or as directed by the online or telephone service and support team. Damage due to servicing that is not authorized by Dell is not covered by your warranty. Read and follow the safety instructions that came with the product.





Steps

- Verify that both the power supply units are the same type and have the same maximum output power.
 - 🔧 NOTE:** The maximum output power (shown in watts) is listed on the power supply label.
- If applicable, remove the power supply unit blank.
- Slide the new power supply unit into the chassis until the power supply unit is fully seated and the release latch snaps into place.
 - 🔧 NOTE:** If you unlatched the cable management arm, re-latch it. For information about the cable management arm, see the system's rack documentation.
- Connect the power cable to the power supply unit and plug the cable into a power outlet.
 - ⚠ CAUTION:** When connecting the power cable, secure the cable with the strap.

-  **NOTE:** When installing, hot-swapping, or hot-adding a new power supply unit, wait for 15 seconds for the system to recognize the power supply unit and determine its status. The power supply redundancy may not occur until discovery is complete. Wait until the new power supply unit is discovered and enabled before you remove the other power supply unit. The power-supply unit status indicator turns green to signify that the power supply unit is functioning properly.

Wiring instructions for a DC power supply unit

Your system supports up to two –(48–60) V DC power supplies (when available).

-  **WARNING:** For equipment using –(48–60) V DC power supplies, a qualified electrician must perform all connections to DC power and to safety grounds. Do not attempt connecting to DC power or installing grounds yourself. All electrical wiring must comply with applicable local or national codes and practices. Damage due to servicing that is not authorized by Dell is not covered by your warranty. Read and follow all safety instructions that came with the product.
-  **CAUTION:** Wire the unit with copper only, unless otherwise specified, use only 10 American Wire Gauge (AWG) wire rated minimum 90 °C for source and return. Protect the –(48–60) V DC (1 wire) with a branch circuit over-current protection rated 50 A for DC with a high interrupt current rating.
-  **CAUTION:** Connect the equipment to a –(48–60) V DC supply source that is electrically isolated from the AC source (reliably grounded –(48–60) V DC SELV source). Ensure that the –(48–60) V DC source is efficiently secured to earth (ground).
-  **NOTE:** A readily accessible disconnect device that is suitably approved and rated shall be incorporated in the field wiring.

Input requirements

- Supply voltage: –(48–60) V DC
- Current consumption: 32 A (maximum)

Kit contents

- Dell part number 6RYJ9 terminal block or equivalent (1)
- #6-32 nut equipped with lock washer (1)

Required tools

Wire-stripper pliers capable of removing insulation from size 10 AWG solid or stranded, insulated copper wire



-  **NOTE:** Use alpha wire part number 3080 or equivalent (65/30 stranding)

Required wires

- One UL 10 AWG, 2 m maximum (stranded) black wire [–(48–60) V DC]
- One UL 10 AWG, 2 m maximum (stranded) red wire (V DC return)
- One UL 10 AWG, 2 m maximum green/yellow, green with a yellow stripe, stranded wire (safety ground)

Removing a DC power supply unit

Prerequisites

-  **WARNING:** For equipment using $-48-60$ V DC power supplies, a qualified electrician must perform all connections to DC power and to safety grounds. Do not attempt connecting to DC power or installing grounds yourself. All electrical wiring must comply with applicable local or national codes and practices. Damage due to servicing that is not authorized by Dell is not covered by your warranty. Read and follow all safety instructions that came with the product.
-  **CAUTION:** The system requires one power supply for normal operation. On power-redundant systems, remove and replace only one power supply at a time in a system that is powered on.
-  **NOTE:** You may have to unlatch and lift the optional cable management arm if it interferes with power supply removal. For information about the cable management arm, see the system's rack documentation.

Steps

1. Disconnect the power wires from the power source and the connector from the power supply you intend to remove.
2. Disconnect the safety ground wire.
3. Press the release latch and slide the power supply out of the chassis.

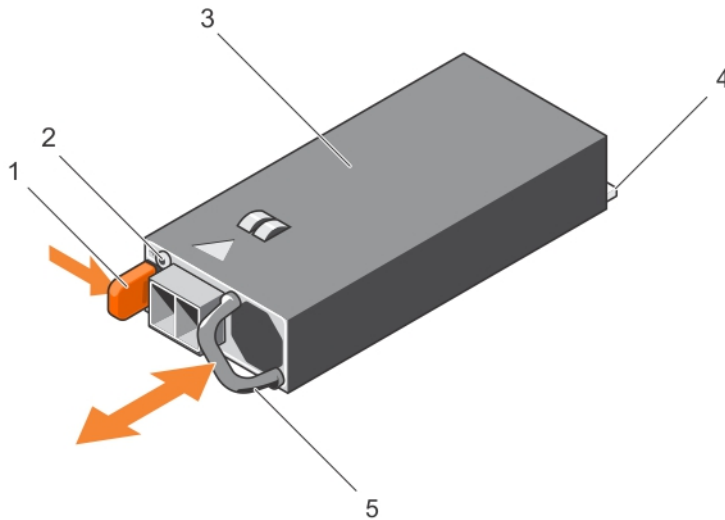



Figure 44. Removing and installing a DC power supply

- | | |
|------------------------|----------------------------------|
| 1. release latch | 2. power supply status indicator |
| 3. power supply | 4. connector |
| 5. power supply handle | |

Installing a DC power supply unit

Prerequisites

-  **WARNING:** For equipment using –(48–60) V DC power supplies, a qualified electrician must perform all connections to DC power and to safety grounds. Do not attempt connecting to DC power or installing grounds yourself. All electrical wiring must comply with applicable local or national codes and practices. Damage due to servicing that is not authorized by Dell is not covered by your warranty. Read and follow all safety instructions that came with the product.

Steps

1. Verify that both the power supplies are of the same type and have the same maximum output power.

 **NOTE:** The maximum output power (shown in watts) is listed on the power supply label.

2. If installed, remove the power supply blank.
3. Slide the new power supply unit into the chassis until the power supply unit is fully seated and the release latch snaps into place.

 **NOTE:** If you unlatched the cable management arm, relatch it. For information about the cable management arm, see the system's rack documentation.

4. Connect the safety ground wire.
5. Install the DC power connector in the power supply unit.

 **CAUTION:** When connecting the power wires, secure the wires with the strap to the power supply handle.

6. Connect the wires to a DC power source.

 **NOTE:** When installing, hot-swapping, or hot-adding a new power supply, wait for 15 seconds for the system to recognize the power supply and determine its status. The power-supply status indicator turns green to signify that the power supply is functioning properly.

System battery

Replacing the system battery

Prerequisites

1. Ensure that you read the [Safety instructions](#).
2. Follow the procedure listed in [Before working inside your system](#).
3. Remove the cooling shroud.

 **WARNING:** There is a danger of a new battery exploding if it is incorrectly installed. Replace the battery only with the same or equivalent type recommended by the manufacturer. See your safety information for additional information.

 **CAUTION:** Many repairs may only be done by a certified service technician. You should only perform troubleshooting and simple repairs as authorized in your product documentation, or as directed by the online or telephone service and support team. Damage due to servicing that is not authorized by Dell is not covered by your warranty. Read and follow the safety instructions that came with the product.

Steps

1. Locate the battery socket. For more information, see [System Board Connectors](#).

△ CAUTION: To avoid damage to the battery connector, you must firmly support the connector while installing or removing a battery.

2. Place your finger between the securing tabs at the negative side of the battery connector and lift the battery out of the socket.

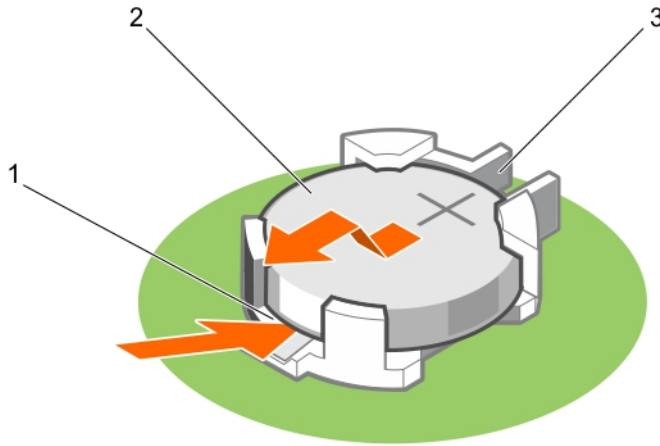

Figure 45. Removing the system battery

1. positive side of the battery connector
 2. system battery
 3. negative side of the battery connector
3. To install a new system battery, hold the battery with the "+" facing up and slide it under the securing tabs.
 4. Press the battery into the connector until it snaps into place.

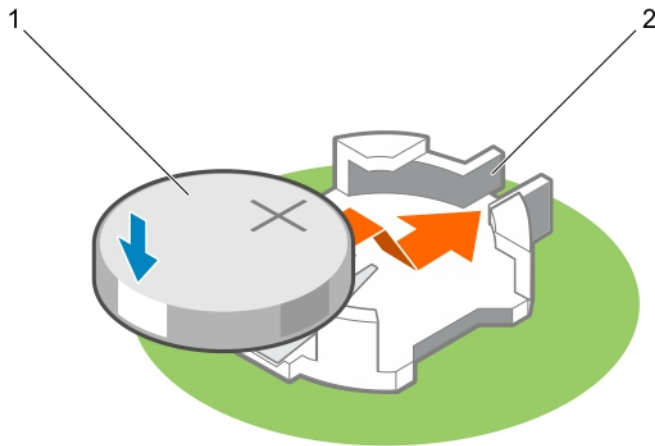

Figure 46. Installing the system battery

1. system battery
2. positive side of the battery connector

Next steps

1. Install the cooling shroud.
2. Follow the procedure listed in [After working inside your system](#).
3. While booting, press <F2> to enter the System Setup and ensure the battery is operating properly.
4. Enter the correct time and date in the System Setup **Time** and **Date** fields.
5. Exit the System Setup.

Hard-drive backplane

Depending on your configuration,

8–Hard-drive system supports	2.5 inch (x4) SAS/SATA backplane
10–Hard-drive system supports	2.5 inch (x10) SAS/SATA backplane that supports X10 and 4 (PCIe SSDs) + 6
24–Hard-drive system supports	1.8 inch (x24) SAS/SATA backplane

Removing the hard-drive backplane

Prerequisites

1. Ensure that you read the [Safety instructions](#).

2. Follow the procedure listed in [Before working inside your system](#).
3. Remove all hard drives.

CAUTION: Many repairs may only be done by a certified service technician. You should only perform troubleshooting and simple repairs as authorized in your product documentation, or as directed by the online or telephone service and support team. Damage due to servicing that is not authorized by Dell is not covered by your warranty. Read and follow the safety instructions that came with the product.

CAUTION: To prevent damage to the hard drives and hard-drive backplane, you must remove the hard drives from the system before removing the hard-drive backplane.

CAUTION: You must note the number of each hard drive and temporarily label them before removal so that you can replace them in the same locations.

Steps

1. Disconnect the SAS/SATA/SSD data cable(s) and power cable from the backplane.
2. If applicable, disconnect the power/data cable from the optical drive.
3. Push the backplane blue release tabs in the direction of the arrows and lift the backplane upwards.
4. Pull the backplane away from the system until the securing slots on the backplane are free from the tabs on the chassis.

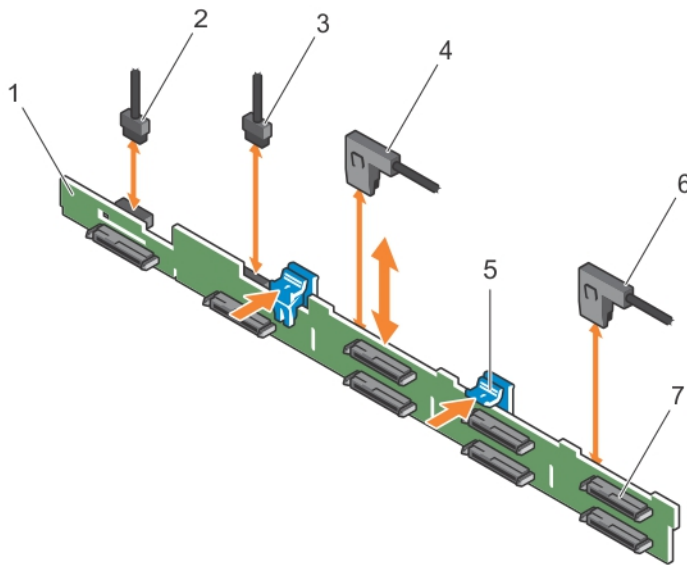

Figure 47. Removing and installing the 2.5 Inch (x8) hard-drive backplane

- | | |
|--|---------------------------|
| 1. backplane | 2. backplane signal cable |
| 3. backplane signal cable | 4. SAS A cable |
| 5. release tabs (2) | 6. SAS B cable |
| 7. SAS hard-drive connector on backplane | |

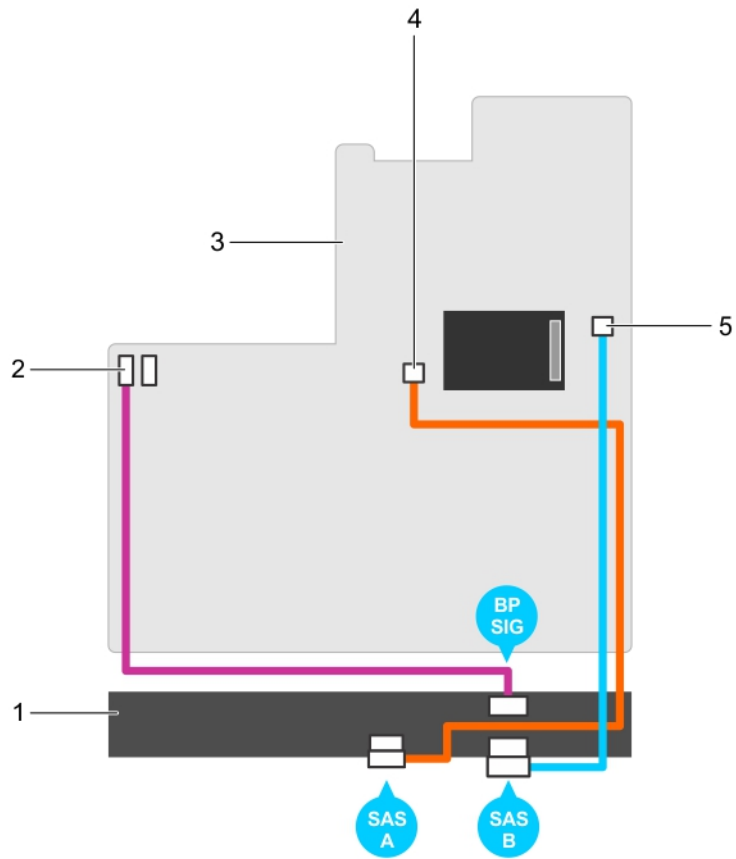

Figure 48. Cabling diagram—2.5 Inch (x8) systems

- | | |
|------------------------------------|-------------------------------------|
| 1. SAS backplane | 2. signal connector on system board |
| 3. system board | 4. SAS A connector on system board |
| 5. SAS B connector on system board | |

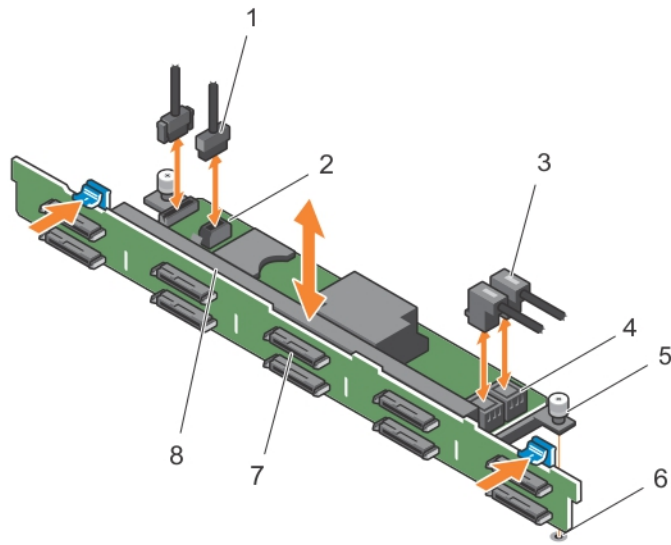

Figure 49. Removing and installing the 2.5 Inch (x10) hard-drive backplane

- | | |
|-------------------------|------------------------------|
| 1. SD signal cable | 2. SD signal cable connector |
| 3. SAS cables(2) | 4. SAS cable connector (2) |
| 5. guide pin | 6. guide pin slot |
| 7. hard-drive connector | 8. SAS backplane |

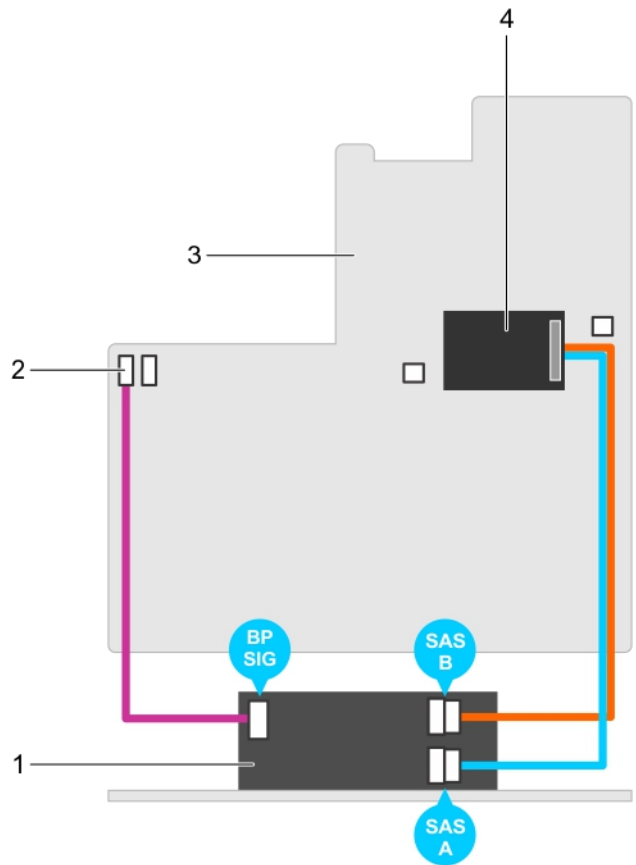

Figure 50. Cabling diagram—2.5 Inch (x10) systems

- | | |
|--------------------------------|---|
| 1. SAS backplane expander card | 2. signal cable connector on the system board |
| 3. system board | 4. integrated storage controller card |

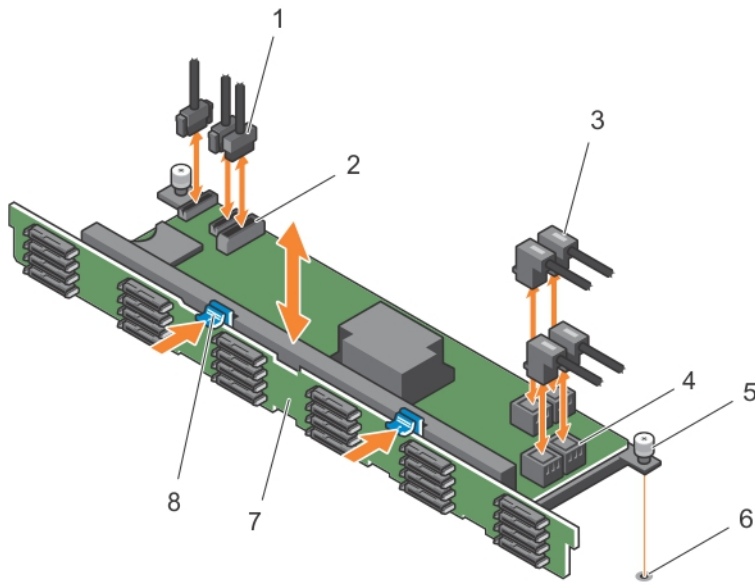

Figure 51. Removing and installing the 1.8 Inch (x24) hard-drive backplane

- | | |
|------------------------|----------------------------------|
| 1. SD signal cable (3) | 2. SD signal cable connector (2) |
| 3. SAS cables(4) | 4. SAS cable connector (4) |
| 5. guide pin | 6. guide pin slot |
| 7. SAS backplane | 8. release tab (2) |

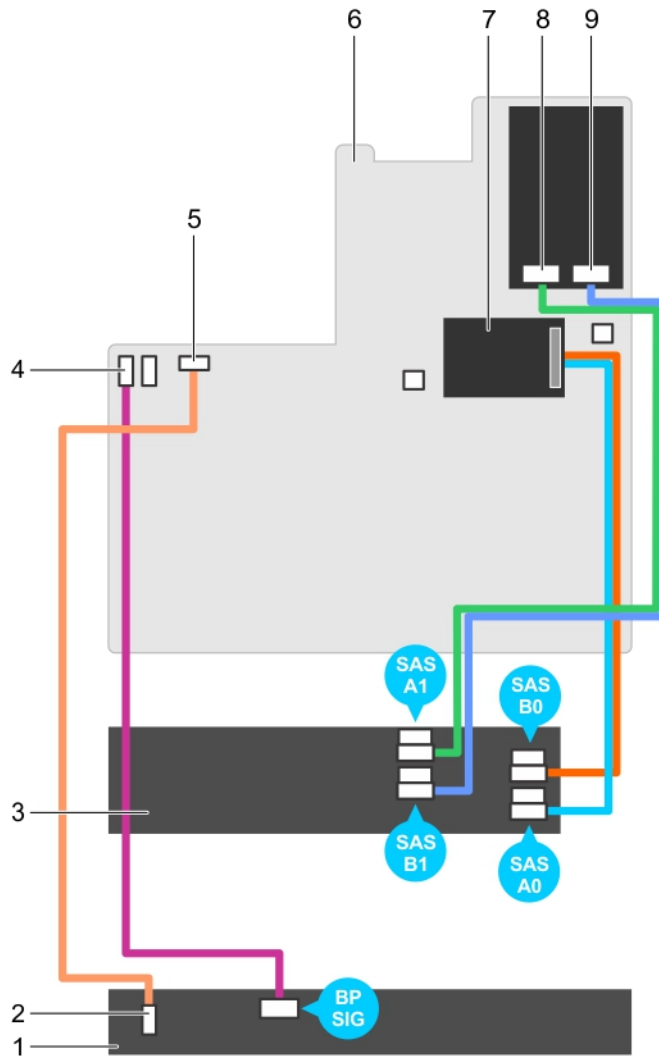

Figure 52. Cabling diagram—1.8 Inch (x24) systems

- | | |
|---------------------------------------|----------------------------------|
| 1. SAS backplane | 2. SD signal cable connector |
| 3. SAS backplane expander card | 4. SD signal cable connector |
| 5. SD signal cable connector | 6. system board |
| 7. integrated storage controller card | 8. SAS connector on system board |
| 9. SAS connector on system board | |

Installing the hard-drive backplane

Prerequisites

1. Ensure that you read the [Safety instructions](#).

2. Follow the procedure listed in [Before working inside your system](#).

 **CAUTION:** Many repairs may only be done by a certified service technician. You should only perform troubleshooting and simple repairs as authorized in your product documentation, or as directed by the online or telephone service and support team. Damage due to servicing that is not authorized by Dell is not covered by your warranty. Read and follow the safety instructions that came with the product.

Steps

1. Use the hooks on the chassis as guides to align the hard-drive backplane.
2. Lower the hard-drive backplane until the release tabs snap into place.
3. Connect the SAS/SATA/SSD data, signal, and power cable(s) to the backplane.

Next steps

1. Install the hard drives in their original locations.
2. Follow the procedure listed in [After working inside your system](#).

Control Panel Assembly

Removing the control panel board—8 hard drive system

Prerequisites

1. Ensure that you read the [Safety instructions](#).
2. Follow the procedure listed in [Before working inside your system](#).
3. Keep the #2 Phillips screwdriver ready.

 **CAUTION:** Many repairs may only be done by a certified service technician. You should only perform troubleshooting and simple repairs as authorized in your product documentation, or as directed by the online or telephone service and support team. Damage due to servicing that is not authorized by Dell is not covered by your warranty. Read and follow the safety instructions that came with the product.

 **CAUTION:** The display module connector is a ZIF (zero insertion force) connector. Ensure that the locking tab on the connector is released before removal and insertion. The locking tab must be engaged after insertion.

Steps

1. Disconnect the control panel and display module cables from the control panel board.
2. Using a #2 Phillips screwdriver, remove the two screws that secure the control panel board to the chassis.
3. Slide the control panel board toward the back and out of the system.

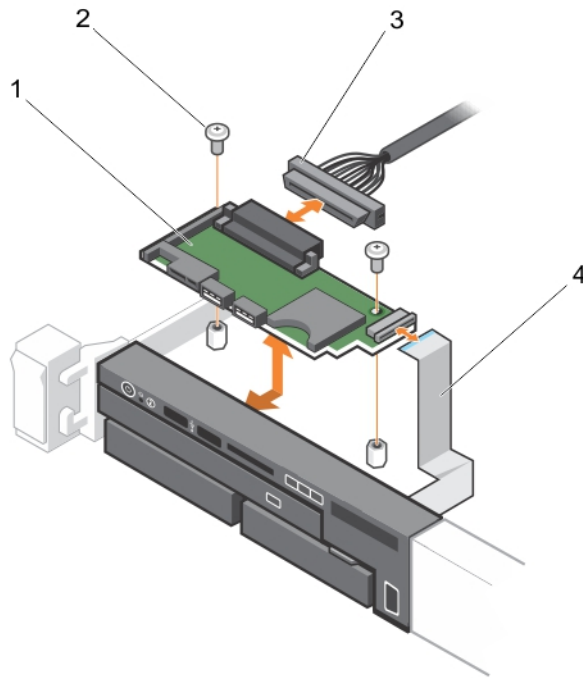

Figure 53. Removing and installing the control panel board

- | | |
|------------------------|-------------------------|
| 1. control panel board | 2. screws (2) |
| 3. control-panel cable | 4. display module cable |

Installing the control panel board—8 hard drive system

Prerequisites

△ CAUTION: Many repairs may only be done by a certified service technician. You should only perform troubleshooting and simple repairs as authorized in your product documentation, or as directed by the online or telephone service and support team. Damage due to servicing that is not authorized by Dell is not covered by your warranty. Read and follow the safety instructions that came with the product.

Keep the #2 Phillips screwdriver ready.

Steps

1. Align the screw holes on the control panel board with the standoffs on the chassis.
2. Using a #2 Phillips screwdriver, replace the two screws that secure the control panel board to the chassis.

△ CAUTION: The display module connector is a ZIF (zero insertion force) connector. Ensure that the locking tab on the connector is released before removal and insertion. The locking tab must be engaged after insertion.
3. Connect control panel and display module cables to the control panel board.
4. If required, route the power/data cables along the chassis wall.

Next steps

Follow the procedure listed in [After working inside your system](#).

Removing the control panel—8 hard—drive system

Prerequisites

1. Ensure that you read the [Safety instructions](#).
2. Follow the procedure listed in [Before working inside your system](#).
3. Keep the #1 Philips screwdriver ready.

 **CAUTION:** Many repairs may only be done by a certified service technician. You should only perform troubleshooting and simple repairs as authorized in your product documentation, or as directed by the online or telephone service and support team. Damage due to servicing that is not authorized by Dell is not covered by your warranty. Read and follow the safety instructions that came with the product.

 **CAUTION:** The display module connector is a ZIF (zero insertion force) connector. Ensure that the locking tab on the connector is released before removal and insertion. The locking tab must be engaged after insertion.

Steps

1. Disconnect the display module cable from the control panel board.
2. Using a #1 Philips screwdriver, remove the screw (located at the bottom of the chassis) that secures the control module to the chassis.

 **NOTE:** Apart from the screw, the control panel has three tabs (one on the left and two tabs on top) that secure it to the chassis.

 **CAUTION:** Applying excessive force while pulling upward may damage the control panel.

3. Hold the top edge of the control panel at the corners and pull upward until the control panel tabs are released.
4. Hold the right edge of the control panel and rotate it toward the left until it is released from the chassis.
5. Pull the control panel away from the chassis.

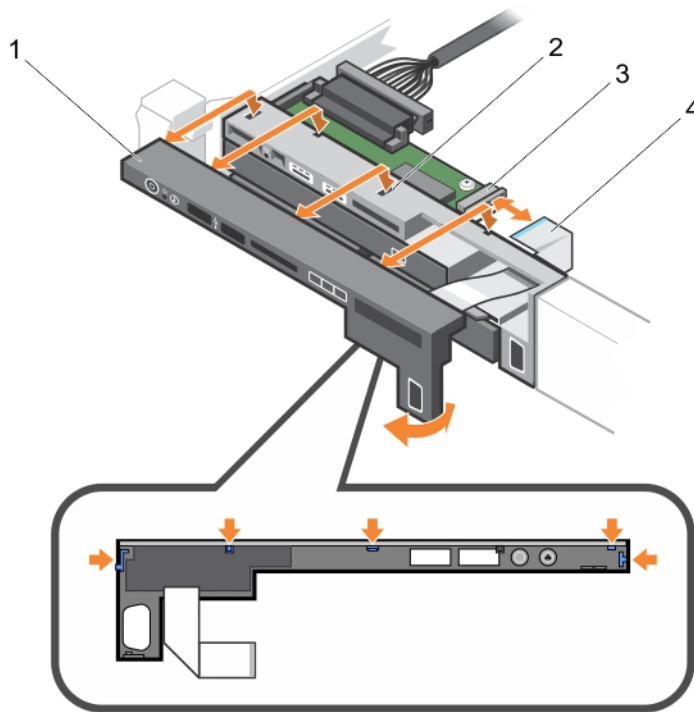

Figure 54. Removing and installing the control panel

- | | |
|---------------------------------|------------------------------------|
| 1. control panel | 2. notch on chassis front wall (2) |
| 3. display module ZIF connector | 4. display module cable |

Installing the control panel–8 hard drive system

Prerequisites

△ CAUTION: Many repairs may only be done by a certified service technician. You should only perform troubleshooting and simple repairs as authorized in your product documentation, or as directed by the online or telephone service and support team. Damage due to servicing that is not authorized by Dell is not covered by your warranty. Read and follow the safety instructions that came with the product.

Keep the #1 Philips screwdriver ready.

Steps

1. Slide the left side of the control panel into the chassis so that the left tab on the control panel aligns with the slot on the chassis wall and the top left tab aligns with the slot on the top of the chassis.
2. Pull the display module cable through the opening and into the chassis.
3. Push the right side of the control panel until the top right tab aligns with the top of the chassis and the panel snaps into place.
4. Using a #1 Philips screwdriver, replace the screw (located at the bottom of the chassis) that secures the control module to the chassis.

 **CAUTION:** The display module connector is a ZIF (zero insertion force) connector. Ensure that the locking tab on the connector is released before removal and insertion. The locking tab must be engaged after insertion.

5. Connect the display module cable to the control panel board.

Next steps

Follow the procedure listed in [After working inside your system](#).

Removing the control panel–10 hard–drive and 24–hard drive system

Prerequisites

1. Ensure that you read the [Safety instructions](#).
2. Follow the procedure listed in [Before working inside your system](#).
3. Keep the #1 Philips screwdriver ready.

 **CAUTION:** Many repairs may only be done by a certified service technician. You should only perform troubleshooting and simple repairs as authorized in your product documentation, or as directed by the online or telephone service and support team. Damage due to servicing that is not authorized by Dell is not covered by your warranty. Read and follow the safety instructions that came with the product.

Steps

1. Using a #1 Philips screwdriver, remove the screw (located at the bottom of the chassis) that secures the control panel to the chassis.
2. Remove the control panel cable from the connectors on the system board (J_CP and J_FP_USB) and the hard-drive expander card.

 **NOTE:** To locate the connectors on the system board, see System Board Connectors.

3. Press the control panel latch and slide the control panel out of the chassis.
4. Disconnect the control panel cable from the control panel.

Next steps

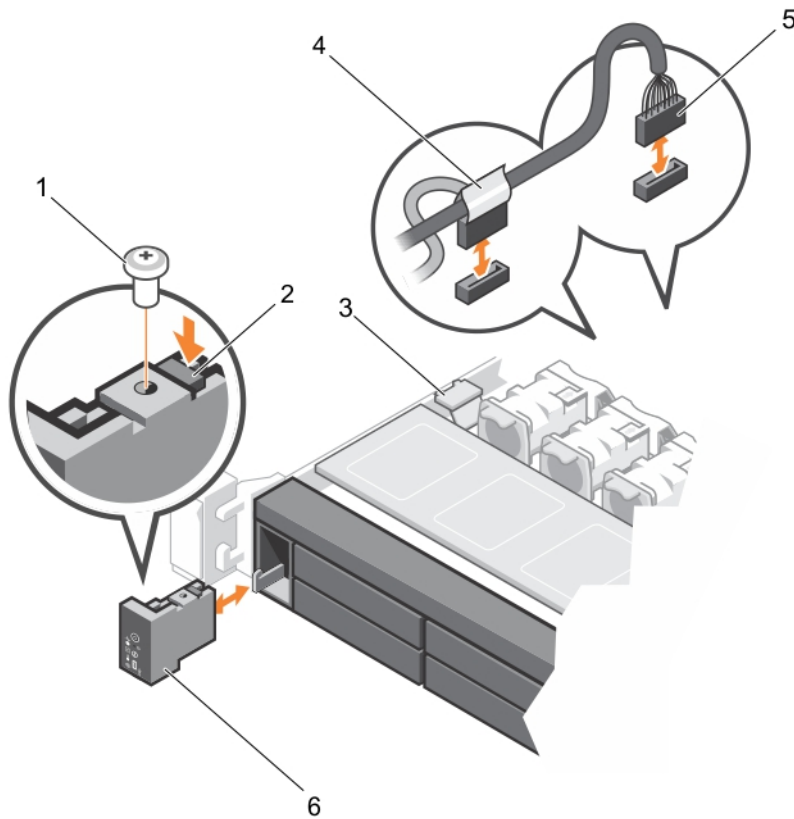

Figure 55. Removing and installing the control panel

- | | |
|---|-----------------------------|
| 1. control panel release latch | 2. cable securing clip |
| 3. control panel cable connecting to system board | 4. J_FP_USB connector cable |
| 5. screw | 6. control panel |

Installing the control panel–10 hard–drive system and 24 hard–drive system



Prerequisites

△ CAUTION: Many repairs may only be done by a certified service technician. You should only perform troubleshooting and simple repairs as authorized in your product documentation, or as directed by the online or telephone service and support team. Damage due to servicing that is not authorized by Dell is not covered by your warranty. Read and follow the safety instructions that came with the product.

Keep the #1 Philips screwdriver ready.

Steps

1. Route the control panel cable through the chassis and connect the control panel cable to the control panel.
2. Push the control panel into the chassis till it snaps into place.

3. Using a #1 Philips screwdriver, replace the screw (located at the bottom of the chassis) that secures the control panel to the chassis.
4. Locate the connectors J_CP and J_FP_USB on the system board.
 -  **NOTE:** To locate the connectors on the system board, see System Board Connectors.
5. Connect the control panel cable to the connectors on the system board (J_CP and J_FP_USB) and the hard-drive expander card.
 -  **NOTE:** Ensure that the control panel cable inside the system is routed along the chassis wall and secured using the cable securing bracket.

Next steps

Follow the procedure listed in [After working inside your system](#).

VGA Module

-  **NOTE:** Only the 8-hard drive system has a VGA module on the front panel.

Removing the VGA module

Prerequisites

1. Ensure that you read the [Safety instructions](#).
2. Follow the procedure listed in [Before working inside your system](#).

 **CAUTION:** Many repairs may only be done by a certified service technician. You should only perform troubleshooting and simple repairs as authorized in your product documentation, or as directed by the online or telephone service and support team. Damage due to servicing that is not authorized by Dell is not covered by your warranty. Read and follow the safety instructions that came with the product.

-  **NOTE:** This procedure applies only to the 8-hard drive system.

 **CAUTION:** The display module connector is a ZIF (zero insertion force) connector. Ensure that the locking tab on the connector is released before removal and insertion. The locking tab must be engaged after insertion.

Steps

1. Disconnect the display module cable from the control panel board.
2. Remove the control panel.
3. Disconnect the VGA module cable from the VGA module.
4. Using a #2 Philips screwdriver, remove the screw that secures the VGA module to the chassis.
5. Slide the VGA module out of the chassis.

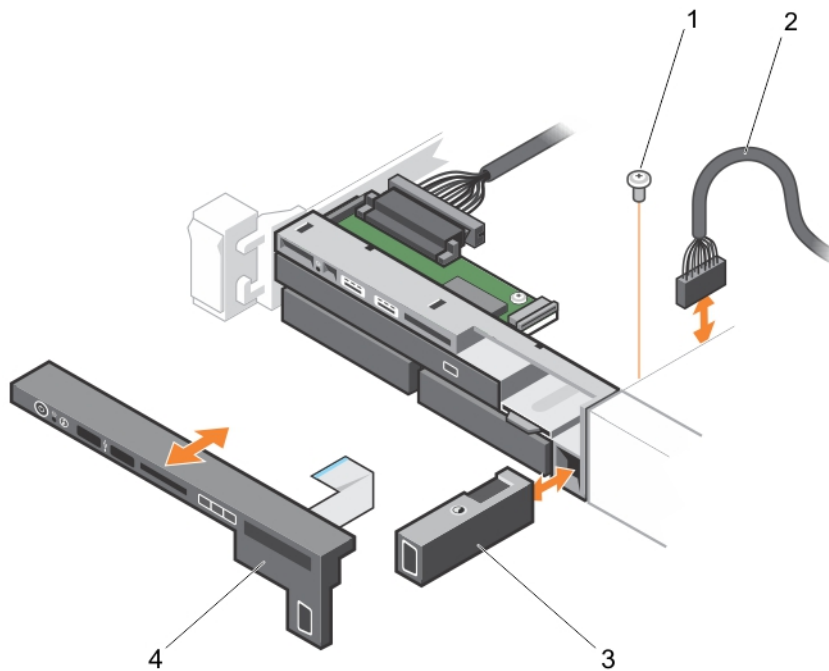



Figure 56. Removing and Installing the VGA Module

- | | |
|---------------|---------------------|
| 1. screw | 2. VGA module cable |
| 3. VGA module | 4. control panel |

Installing the VGA module

Prerequisites

 **NOTE:** This procedure applies only to the 8-hard drive system.

 **CAUTION:** Many repairs may only be done by a certified service technician. You should only perform troubleshooting and simple repairs as authorized in your product documentation, or as directed by the online or telephone service and support team. Damage due to servicing that is not authorized by Dell is not covered by your warranty. Read and follow the safety instructions that came with the product.

Steps

1. Push the VGA module into the chassis and align the threaded screw hole on the VGA module with the screw hole on the chassis.
2. Using a #2 Philips screwdriver, replace the screw (at the bottom of the chassis) that secures the VGA module to the chassis.
3. Replace the control panel.
4. Connect the VGA module cable to the VGA module.

 **CAUTION:** The display module connector is a ZIF (zero insertion force) connector. Ensure that the locking tab on the connector is released before removal and insertion. The locking tab must be engaged after insertion.

5. Connect the display module cables to the control panel board.

Next steps

Follow the procedure listed in [After working inside your system](#).

System board

Removing the system board

Prerequisites

 **CAUTION:** Many repairs may only be done by a certified service technician. You should only perform troubleshooting and simple repairs as authorized in your product documentation, or as directed by the online or telephone service and support team. Damage due to servicing that is not authorized by Dell is not covered by your warranty. Read and follow the safety instructions that came with the product.

 **CAUTION:** If you are using the Trusted Platform Module (TPM) with an encryption key, you may be prompted to create a recovery key during program or System Setup. Be sure to create and safely store this recovery key. If you replace this system board, you must supply the recovery key when you restart your system or program before you can access the encrypted data on your hard drives.

 **CAUTION:** Do not attempt to remove the TPM plug-in module from the motherboard. Once the TPM plug-in module is installed, it is cryptographically bound to that specific motherboard. Any attempt to remove an installed TPM plug-in module breaks the cryptographic binding, and it cannot be re-installed or installed on another motherboard.

1. Ensure that you read the [Safety instructions](#).
2. Follow the procedure listed in [Before working inside your system](#).
3. Remove the following:
 - a. cooling shroud
 - b. memory modules
 - c. cooling fans
 - d. power supply(s)
 - e. all expansion-card risers and expansion cards

 **WARNING:** The heat sink is hot to touch for some time after the system has been powered down. Ensure that you do not touch the heat sink(s) while removing the system board.

- f. heat sink(s)/heat-sink blanks and processors(s)/processor blanks

 **CAUTION:** To prevent damage to the processor pins when replacing a faulty system board, ensure that you cover the processor socket with the processor protective cap.

- g. integrated storage controller card
- h. network daughter card
- i. internal dual SD module

- j. internal USB key (if installed)
- k. hot-swap hard drives
- l. hard-drive backplane

 **CAUTION: To avoid damaging the mini SAS cable and connector, follow the correct procedure when removing the mini SAS cable from the system board.**

Steps

1. Disconnect the mini SAS cable from the system board:
 - a. Push the mini SAS cable connector to slide it further into the connector on the system board.
 - b. Press down and hold the metal tab on the mini SAS cable connector.
 - c. Pull the mini SAS cable out of the connector on the system board.
2. Disconnect all other cables from the system board.

 **CAUTION: Take care not to damage the system identification button while removing the system board from the chassis.**

3. Grasp the system-board holder, lift the blue release pin, slide the system board toward the front of the system, and lift the system board out of the chassis.

 **CAUTION: Do not lift the system board assembly by grasping a memory module, processor, or other components.**

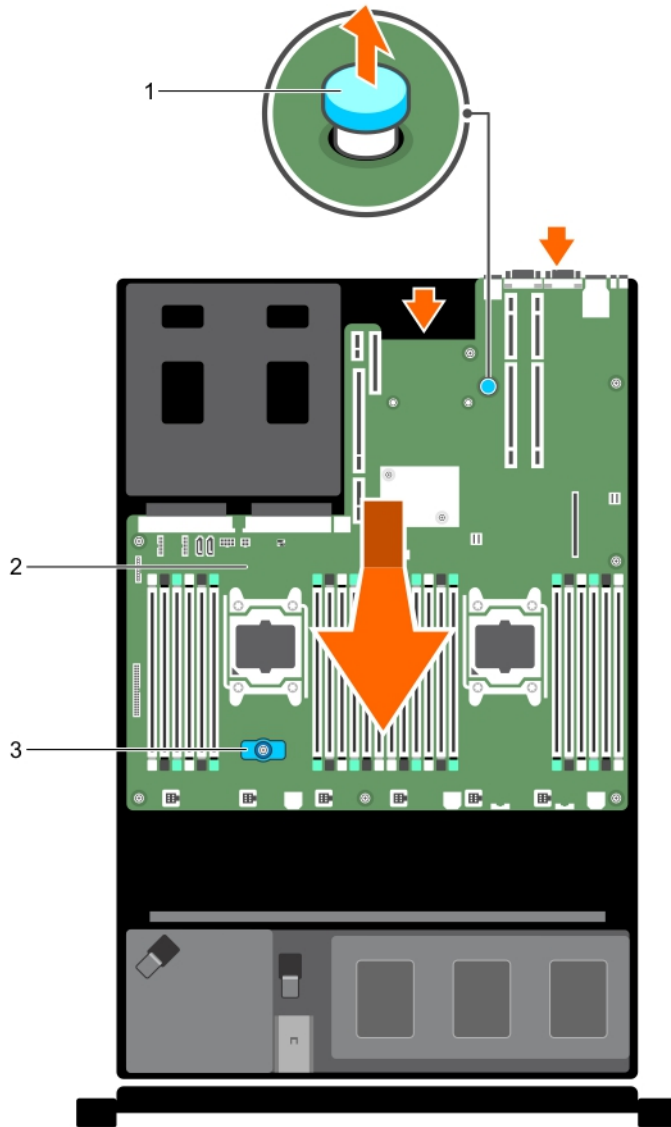

Figure 57. Removing and Installing the System Board

- 1. system board holder
- 2. system-board
- 3. release pin

Installing the system board

Prerequisites

CAUTION: Many repairs may only be done by a certified service technician. You should only perform troubleshooting and simple repairs as authorized in your product documentation, or as directed by the online or telephone service and support team. Damage due to servicing that is not authorized by Dell is not covered by your warranty. Read and follow the safety instructions that came with the product.

Steps

1. Unpack the new system board assembly.

 **CAUTION: Do not lift the system board assembly by grasping a memory module, processor, or other components.**

 **CAUTION: Take care not to damage the system identification button while placing the system board into the chassis.**

2. Hold the touch points and lower the system board into the chassis.
3. Push the system board toward the back of the chassis until the board is seated correctly.

Next steps

1. Install the Trusted Platform Module (TPM). For information on how to install TPM, [Installing the Trusted Platform Module](#). For more information on TPM, see [Trusted Platform Module](#).

2. Replace the following:

- a. cable retention bracket
- b. PCIe card holder
- c. integrated storage controller card
- d. internal USB key (if installed)
- e. internal dual SD module
- f. all expansion-card risers
- g. heat sink(s)/heat-sink blank(s) and processors(s)/processor blank(s)
- h. memory modules and memory module blanks
- i. network daughter card
- j. cooling-fan assembly
- k. cooling shroud
- l. power supply unit(s)

3. Reconnect all cables to the system board.

 **NOTE:** Ensure that the cables inside the system are routed along the chassis wall and secured using the cable securing bracket.

4. Follow the procedure listed in [After working inside your system](#).
5. Import your new or existing iDRAC Enterprise license. For more information, see the Integrated Dell Remote Access Controller User's Guide, at dell.com/esmmanuals.
6. Ensure that you:

- a. Use the **Easy Restore** feature to restore the service tag. For more information, see [Easy Restore](#).
- b. If the service tag is not backed up in the backup flash device, enter the system service tag manually. For more information, see [Entering the system service tag](#).
- c. Update the BIOS and iDRAC versions.
- d. Re-enable the Trusted Platform Module (TPM). For more information, see [Re-enabling the TPM for BitLocker users](#) or [Re-enabling the TPM for Intel TXT users](#).

Entering the system service tag using System Setup

If you know the system service tag, use the System Setup menu to enter the service tag.

1. Turn on the system.
2. Press <F2> to enter the System Setup.
3. Click **Service Tag Settings**.
4. Enter the service tag.



NOTE: You can enter the service tag only when the **Service Tag** field is empty. Ensure that you enter the correct service tag. Once the service tag is entered, it cannot be updated or changed.

5. Click **Ok**.

Restoring the service tag using Easy Restore

Use the Easy Restore feature if you do not know the service tag of your system. The Easy Restore feature allows you to restore your system's service tag, license, UEFI configuration, and the system configuration data after replacing the system board. All data is backed up in a backup flash device automatically. If BIOS detects a new system board and the service tag in the backup flash device, BIOS prompts the user to restore the backup information.

1. Turn on the system.
If BIOS detects a new system board, and if the service tag is present in the backup flash device, BIOS displays the service tag, the status of the license, and the **UEFI Diagnostics** version.
2. Do one of the following:
 - Press **Y** to restore the service tag, license, and diagnostics information.
 - Press **N** to navigate to the Lifecycle Controller based restore options.
 - Press <F10> to restore data from a previously created **Hardware Server Profile**.

After the restore process is complete, BIOS prompts to restore the system configuration data.

3. Do one of the following:
 - Press **Y** to restore the system configuration data.
 - Press **N** to use the default configuration settings.

After the restore process is complete, the system reboots.

Trusted Platform Module

The Trusted Platform Module (TPM) is used to generate/store keys, protect/authenticate passwords, and create/store digital certificates. TPM can also be used to enable the BitLocker hard drive encryption feature in Windows Server.

Installing the Trusted Platform Module

Prerequisites

Ensure that you read the [Safety instructions](#).



CAUTION: Do not remove an installed Trusted Platform Module (TPM). Any attempt to remove an installed TPM from the system board may damage the TPM.

Steps

1. Align the edge connectors on the TPM with the slot on the TPM connector.
2. Insert the TPM into the TPM connector such that the plastic bolt aligns with the slot on the system board.
3. Press the plastic bolt until the bolt snaps into place.

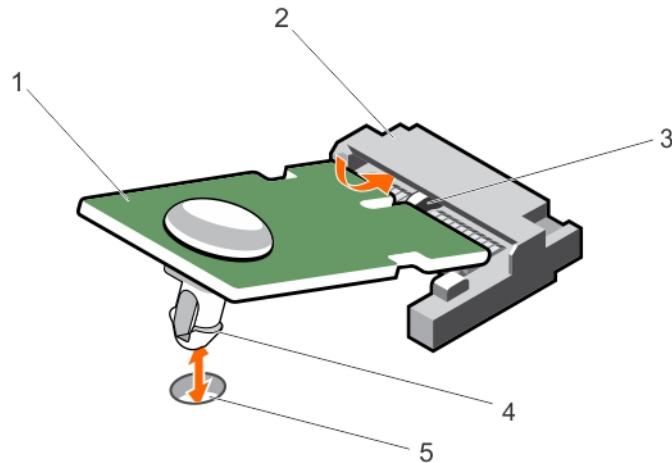

Figure 58. Installing the TPM

- | | |
|------------------------------|------------------|
| 1. TPM | 2. TPM connector |
| 3. slot on the TPM connector | 4. plastic bolt |
| 5. slot on the system board | |

Re-enabling the TPM for BitLocker users

Initialize the TPM.

For more information on initializing the TPM, see <http://technet.microsoft.com/en-us/library/cc753140.aspx>.

The **TPM Status** changes to **Enabled, Activated**.

Re-enabling the TPM for TXT users

1. While booting your system, press <F2> to enter System Setup.
2. In the **System Setup Main Menu**, click **System BIOS** → **System Security Settings**.
3. In the **TPM Security** option, select **On with Pre-boot Measurements**.
4. In the **TPM Command** option, select **Activate**.
5. Save the settings.
6. Reboot your system.

7. Enter System Setup again.
8. In the **System Setup Main Menu**, click **System BIOS** → **System Security Settings**.
9. In the **Intel TXT** option, select **On**.

Troubleshooting your system

Safety first—for you and your system

 **CAUTION:** Many repairs may only be done by a certified service technician. You should only perform troubleshooting and simple repairs as authorized in your product documentation, or as directed by the online or telephone service and support team. Damage due to servicing that is not authorized by Dell is not covered by your warranty. Read and follow the safety instructions that came with the product.

Troubleshooting system startup failure

If you boot the system to the BIOS boot mode after installing an operating system from the UEFI Boot Manager, the system hangs. The reverse is also true. You must boot to the same boot mode in which you installed the operating system.

For all other startup issues, note the system messages that appear on the screen.

Troubleshooting external connections

Ensure that all external cables are securely attached to the external connectors on your system before troubleshooting any external devices.

Troubleshooting the video subsystem

1. Check the system and power connections to the monitor.
2. Check the video interface cabling from the system to the monitor.
3. Run the appropriate diagnostic test.

If the tests run successfully, the problem is not related to video hardware.

If the tests fail, see [Getting Help](#).

Troubleshooting a USB device

About this task

Use the following steps to troubleshoot a USB keyboard/mouse. For other USB devices, go to step 7.

Steps

1. Disconnect the keyboard and mouse cables from the system and reconnect them.
2. If the problem persists, connect the keyboard/mouse to the USB port(s) on the opposite side of the system.

3. If the problem is resolved, restart the system, enter the System Setup, and check if the non-functioning USB ports are enabled.
Check if USB 3.0 is enabled in System Setup. If enabled, disable it and see if the issue is resolved (older operating systems may not support USB 3.0).
4. In the **IDRAC Settings Utility**, ensure the **USB Management Port Mode** is configured as **Automatic** or **Standard OS Use**.
5. Replace the keyboard/mouse with a working keyboard/mouse.
If the problem is not resolved, proceed to the next step to begin troubleshooting other USB devices attached to the system.
6. Power down all attached USB devices and disconnect them from the system.
7. Reboot the system and, if your keyboard is functioning, enter the System Setup.
8. Verify that all USB ports are enabled on the **Integrated Devices** screen, in the System Setup options.
9. Check if USB 3.0 is enabled in System Setup. If it is enabled, disable it and restart your system.
If your keyboard is not functioning, you can also use remote access.
10. If the system is not accessible, reset the NVRAM_CLR jumper inside your system and restore the BIOS to the default settings.
11. In the **IDRAC Settings Utility**, ensure the **USB Management Port Mode** is configured as **Automatic** or **Standard OS Use**.
12. Reconnect and power on each USB device one at a time.
13. If a USB device causes the same problem, power down the device, replace the USB cable with a known good cable, and power up the device.

Next steps

If all troubleshooting fails, see [Getting Help](#).

Troubleshooting iDRAC Direct (USB XML configuration)

For information on USB storage device and server configuration, see the Integrated Dell Remote Access Controller User's Guide at dell.com/esmanuals.

Steps

1. Ensure your USB storage device is connect to the front USB Management Port, identified by  icon.
2. Ensure your USB storage device is configured with an NTFS or a FAT32 file system with only one partition.
3. Verify that the USB storage device is configured correctly. For more information on configuring the USB storage device, see the Integrated Dell Remote Access Controller User's Guide at dell.com/esmanuals.
4. In the **IDRAC Settings Utility**, ensure the **USB Management Port Mode** is configured as **Automatic** or **iDRAC Direct Only**.
5. Make sure the **iDRAC Managed: USB XML Configuration** option is either **Enabled** or **Enabled only when the server has default credential settings**.
6. Remove and re-insert the USB storage device.
7. If import operation does not work, try with a different USB storage device.

Next steps

If all troubleshooting fails, see [Getting help](#).

Troubleshooting iDRAC Direct (laptop connection)

For information on USB laptop connection and server configuration, see the Integrated Dell Remote Access Controller User's Guide at dell.com/esmanuals.

Steps

1. Make sure your laptop is connected to the front USB Management Port, identified by  icon with a USB Type A/A cable.
2. In the **iDRAC Settings Utility**, ensure the **USB Management Port Mode** is configured as **Automatic or iDRAC Direct Only**.
3. If the laptop is running the Windows operating system, ensure the iDRAC Virtual USB NIC device driver is installed.
4. If the driver is installed, ensure you are not connected to any network through WiFi or cabled ethernet as iDRAC Direct uses a non-routable address.

Next steps

If all troubleshooting fails, see [Getting help](#).

Troubleshooting a serial I/O device

Steps

1. Turn off the system and any peripheral devices connected to the serial port.
2. Swap the serial interface cable with a working cable, and turn on the system and the serial device.
If the problem is resolved, replace the interface cable with a known good cable.
3. Turn off the system and the serial device, and swap the serial device with a comparable device.
4. Turn on the system and the serial device.

Next steps

If the problem persists, see [Getting Help](#).

Troubleshooting a NIC

Steps

1. Run the appropriate diagnostic test. See [Using System Diagnostics](#) for available diagnostic tests.
2. Reboot the system and check for any system messages pertaining to the NIC controller.
3. Check the appropriate indicator on the NIC connector:
 - If the link indicator does not light, check all cable connections.
 - If the activity indicator does not light, the network driver files might be damaged or missing. Remove and reinstall the drivers if applicable. See the NIC's documentation.
 - If applicable, change the autonegotiation setting.
 - Use another connector on the switch or hub.
4. Ensure that the appropriate drivers are installed and the protocols are bound. See the NIC's documentation.
5. Enter the System Setup and confirm that the NIC ports are enabled on the **Integrated Devices** screen.
6. Ensure that the NICs, hubs, and switches on the network are all set to the same data transmission speed and duplex. See the documentation for each network device.

7. Ensure that all network cables are of the proper type and do not exceed the maximum length.

Next steps

If all troubleshooting fails, see [Getting Help](#).

Troubleshooting a wet system

Prerequisites



CAUTION: Many repairs may only be done by a certified service technician. You should only perform troubleshooting and simple repairs as authorized in your product documentation, or as directed by the online or telephone service and support team. Damage due to servicing that is not authorized by Dell is not covered by your warranty. Read and follow the safety instructions that came with the product.

Steps

1. Turn off the system and attached peripherals, and disconnect the system from the electrical outlet.
2. Remove the system cover.
3. Remove the following components from the system:
 - hard drives
 - hard-drive backplane
 - USB memory key
 - hard-drive tray
 - cooling shroud
 - expansion-card risers (if present)
 - expansion cards
 - power supply unit(s)
 - cooling-fan assembly (if present)
 - cooling fans
 - processor(s) and heat sink(s)
 - memory modules
4. Let the system dry thoroughly for at least 24 hours.
5. Reinstall the components you removed in step 3.
6. Install the system cover.
7. Turn on the system and attached peripherals.
If the system does not start properly, see [Getting Help](#).
8. If the system starts properly, shut down the system, and reinstall all the expansion cards that you removed.
9. Run the appropriate diagnostic test. For more information, see [Using System Diagnostics](#).

Next steps

If the tests fail, see [Getting Help](#).

Troubleshooting a damaged system

Prerequisites

 **CAUTION:** Many repairs may only be done by a certified service technician. You should only perform troubleshooting and simple repairs as authorized in your product documentation, or as directed by the online or telephone service and support team. Damage due to servicing that is not authorized by Dell is not covered by your warranty. Read and follow the safety instructions that came with the product.

Steps

1. Turn off the system and attached peripherals, and disconnect the system from the electrical outlet.
2. Remove the system cover.
3. Ensure that the following components are properly installed:
 - Cooling shroud
 - Expansion-card risers (if present)
 - Expansion cards
 - Power supply(s)
 - Cooling-fan assembly (if present)
 - Cooling fans
 - Processor(s) and heat sink(s)
 - Memory modules
 - Hard-drive carriers
 - Hard-drive backplane
4. Ensure that all cables are properly connected.
5. Install the system cover.
6. Run the appropriate diagnostic test. For more information, see [Using System Diagnostics](#).

Next steps

If the tests fail, see [Getting Help](#).

Troubleshooting the system battery

Prerequisites

 **CAUTION:** Many repairs may only be done by a certified service technician. You should only perform troubleshooting and simple repairs as authorized in your product documentation, or as directed by the online or telephone service and support team. Damage due to servicing that is not authorized by Dell is not covered by your warranty. Read and follow the safety instructions that came with the product.

 **NOTE:** If the system is turned off for long periods of time (for weeks or months), the NVRAM may lose its system configuration information. This situation is caused by a defective battery.

 **NOTE:** Some software may cause the system time to speed up or slow down. If the system seems to operate normally except for the time kept in the System Setup, the problem may be caused by software rather than by a defective battery.

Steps

1. Re-enter the time and date in the System Setup.
2. Turn off the system and disconnect it from the electrical outlet for at least one hour.
3. Reconnect the system to the electrical outlet and turn on the system.
4. Enter the System Setup.
If the date and time are not correct in the System Setup, check the SEL for system battery messages.

Next steps

If the problem persists, see [Getting Help](#).

Troubleshooting power supply units

 **CAUTION:** Many repairs may only be done by a certified service technician. You should only perform troubleshooting and simple repairs as authorized in your product documentation, or as directed by the online or telephone service and support team. Damage due to servicing that is not authorized by Dell is not covered by your warranty. Read and follow the safety instructions that came with the product.

Power source problems

1. Press the power button to ensure that your system is turned on. If the power indicator does not light up when the power button is pressed, press the power-on button firmly.
2. Plug in another working device to ensure that the system board is not faulty.
3. Ensure that no loose connections exist.
For example, loose power cables.
4. Ensure that the power source meets applicable standards.
5. Ensure that there are no short circuits.
6. Have a qualified electrician check the line voltage to ensure that it meets the required specifications.

Power supply unit problems

1. Ensure that no loose connections exist.
For example, loose power cables.
2. Ensure that the power supply handle/LED indicates that the power supply is working properly.
For more information on power supply indicators, see [Power indicator codes](#).
3. If you have recently upgraded your system, ensure that the power supply unit has enough power to support the new system.
4. If you have a redundant power supply configuration, ensure that both the power supply units are of the same type and wattage.
If the LED You may have to upgrade to a higher wattage power supply unit.
5. Ensure that you use only power supply units with the Extended Power Performance (EPP) label on the back.
6. Reseat the power supply unit.

 **NOTE:** After installing a power supply unit, allow several seconds for the system to recognize the power supply unit and determine if it is working properly.

If the problem persists, see [Getting Help](#).

Troubleshooting cooling problems

 **CAUTION:** Many repairs may only be done by a certified service technician. You should only perform troubleshooting and simple repairs as authorized in your product documentation, or as directed by the online or telephone service and support team. Damage due to servicing that is not authorized by Dell is not covered by your warranty. Read and follow the safety instructions that came with the product.

Ensure that the following conditions exist:

- System cover, cooling shroud, EMI filler panel, or back-filler bracket is not removed.
- Ambient temperature is not too high.
- External airflow is not obstructed.
- A cooling fan is not removed or has not failed.
- The expansion card installation guidelines have been followed.

Additional cooling can be added by one of the following methods:

From the iDRAC Web GUI:

1. Click **Hardware** → **Fans** → **Setup**.
2. From the **Fan Speed Offset** drop-down list, select the cooling level needed or set the minimum fan speed to a custom value.

From F2 System Setup

1. Select **iDRAC Settings** → **Thermal**, and set a higher fan speed from the fan speed offset or minimum fan speed.

From RACADM commands

1. Run the command `racadm help system.thermalsettings`

For more information, see the Integrated Dell Remote Access Controller User's Guide at dell.com/esmmanuals.

Troubleshooting cooling fans

Prerequisites

 **CAUTION:** Many repairs may only be done by a certified service technician. You should only perform troubleshooting and simple repairs as authorized in your product documentation, or as directed by the online or telephone service and support team. Damage due to servicing that is not authorized by Dell is not covered by your warranty. Read and follow the safety instructions that came with the product.

 **NOTE:** In the event of a problem with a particular fan, the fan number is referenced by the system's management software, allowing you to easily identify and replace the proper fan by noting the fan numbers on the cooling fan assembly.

Steps

1. Remove the system cover.
2. Reseat the fan or the fan's power cable.

3. If the fan functions properly, install the system cover.

Next steps

If the problem persists, see [Getting Help](#).

Troubleshooting system memory

Prerequisites



CAUTION: Many repairs may only be done by a certified service technician. You should only perform troubleshooting and simple repairs as authorized in your product documentation, or as directed by the online or telephone service and support team. Damage due to servicing that is not authorized by Dell is not covered by your warranty. Read and follow the safety instructions that came with the product.

Steps

1. If the system is operational, run the appropriate diagnostic test. See [Using system diagnostics](#) for available diagnostic tests.
If diagnostics indicate a fault, follow the corrective actions provided by the diagnostic program.
2. If the system is not operational, turn off the system and attached peripherals, and unplug the system from the power source. Wait at least 10 seconds and then reconnect the system to the power source.
3. Turn on the system and attached peripherals and note the messages on the screen.
If an error message is displayed indicating a fault with a specific memory module, go to step 12.
4. Enter the System Setup and check the system memory setting. Make any changes to the memory settings, if needed.
If the memory settings match the installed memory but the problem still persists, go to step 12.
5. Turn off the system and attached peripherals, and disconnect the system from the electrical outlet.
6. Remove the system cover.
7. Check the memory channels and ensure that they are populated correctly.
 **NOTE:** See the system event log or system messages for the location of the failed memory module. Reinstall the memory device.
8. Reseat the memory modules in their sockets.
9. Install the system.
10. Enter the System Setup and check the system memory setting.
If the problem is not resolved, proceed with the next step.
11. Remove the system cover.
12. If a diagnostic test or error message indicates a specific memory module as faulty, swap or replace the module with a known good memory module.
13. To troubleshoot an unspecified faulty memory module, replace the memory module in the first DIMM socket with a module of the same type and capacity.
If an error message is displayed on the screen, this may indicate a problem with the installed DIMM type(s), incorrect DIMM installation, or defective DIMM(s). Follow the on-screen instructions to resolve the problem. For more information, see [General memory module installation guidelines](#).
14. Install the system cover.
15. As the system boots, observe any error message that is displayed and the diagnostic indicators on the front of the system.
16. If the memory problem persists, repeat step 12 through step 15 for each memory module installed.

Next steps

If the problem persists after all memory modules have been checked, see [Getting Help](#).

Troubleshooting an internal USB key

Prerequisites



CAUTION: Many repairs may only be done by a certified service technician. You should only perform troubleshooting and simple repairs as authorized in your product documentation, or as directed by the online or telephone service and support team. Damage due to servicing that is not authorized by Dell is not covered by your warranty. Read and follow the safety instructions that came with the product.

Steps

1. Enter the System Setup and ensure that the **USB key port** is enabled on the **Integrated Devices** screen.
2. Turn off the system and attached peripherals, and disconnect the system from the electrical outlet.
3. Remove the system cover.
4. Locate the USB key and reseal it.
5. Install the system cover.
6. Turn on the system and attached peripherals and check if the USB key is functioning.
7. If the problem is not resolved, repeat step 2 and step 3.
8. Insert a different USB key that you know works properly.
9. Install the system cover.

Next steps

If the problem is not resolved, see [Getting Help](#).

Troubleshooting an SD card

Prerequisites



CAUTION: Many repairs may only be done by a certified service technician. You should only perform troubleshooting and simple repairs as authorized in your product documentation, or as directed by the online or telephone service and support team. Damage due to servicing that is not authorized by Dell is not covered by your warranty. Read and follow the safety instructions that came with the product.



NOTE: Certain SD cards have a physical write-protect switch on the card. If the write-protect switch is turned on, the SD card is not writeable.

Steps

1. Enter the System Setup and ensure that the **Internal SD Card Port** is enabled.
2. Turn off the system, including any attached peripherals, and disconnect the system from the electrical outlet.
3. Remove the system cover.
 -  **NOTE:** When an SD card failure occurs, the internal dual SD module controller notifies the system. On the next reboot, the system displays a message indicating the failure. If redundancy is enabled at the time of SD card failure, a critical alert will be logged and chassis health will degrade.
4. Replace the failed SD card with a new SD card.

5. Install the system cover.
6. Reconnect the system to its electrical outlet and turn the system on, including any attached peripherals.
7. Enter the System Setup and ensure that the **Internal SD Card Port** and **Internal SD Card Redundancy** mode is set to the required mode.
Verify that correct SD slot is set as **Primary SD Card**.
8. Check if the SD card is functioning properly.
9. If the **Internal SD Card Redundancy** option is set to **Enabled** at the time of the SD card failure, the system will prompt you to perform a rebuild.

 **NOTE:** The rebuild will always be sourced from the primary SD card to the secondary SD card. Perform the rebuild of the SD card as necessary.

Troubleshooting an optical drive

Prerequisites

 **CAUTION:** Many repairs may only be done by a certified service technician. You should only perform troubleshooting and simple repairs as authorized in your product documentation, or as directed by the online or telephone service and support team. Damage due to servicing that is not authorized by Dell is not covered by your warranty. Read and follow the safety instructions that came with the product.

Steps

1. Try using a different CD or DVD.
2. Enter the System Setup and ensure that the integrated SATA controller and the drive's SATA port are enabled.
3. Run the appropriate diagnostic test.
4. Turn off the system and attached peripherals, and disconnect the system from the electrical outlet.
5. If installed, remove the front bezel.
6. Remove the system cover.
7. Ensure that the interface cable is securely connected to the optical drive and to the controller.
8. Ensure that a power cable is properly connected to the drive.
9. Install the system cover.

Next steps

If the problem is not resolved, see [Getting Help](#).

Troubleshooting a tape backup unit

Prerequisites

 **CAUTION:** Many repairs may only be done by a certified service technician. You should only perform troubleshooting and simple repairs as authorized in your product documentation, or as directed by the online or telephone service and support team. Damage due to servicing that is not authorized by Dell is not covered by your warranty. Read and follow the safety instructions that came with the product.

Steps

1. Use a different tape cartridge.
2. Ensure that the device drivers for the tape backup unit are installed and are configured correctly. See your tape drive documentation for more information about device drivers.
3. Reinstall the tape-backup software as instructed in the tape-backup software documentation.
4. Ensure that the interface cable of the tape drive is connected to the external port on the controller card.
5. Perform the following steps to ensure that the controller card is properly installed:
 - a. Turn off the system and attached peripherals, and disconnect the system from the electrical outlet.
 - b. Remove the system cover.
 - c. Reseat the controller card in the expansion card slot.
 - d. Install the system cover.
 - e. Turn on the system and attached peripherals.
6. Run the appropriate diagnostic test. For more information, see [Using System Diagnostics](#).

Next steps

If you cannot resolve the problem, see [Getting Help](#).

Troubleshooting a hard drive

Prerequisites



CAUTION: Many repairs may only be done by a certified service technician. You should only perform troubleshooting and simple repairs as authorized in your product documentation, or as directed by the online or telephone service and support team. Damage due to servicing that is not authorized by Dell is not covered by your warranty. Read and follow the safety instructions that came with the product.



CAUTION: This troubleshooting procedure can erase data stored on the hard drive. Before you proceed, back up all files on the hard drive.

Steps

1. Run the appropriate diagnostic test. For more information, see [Using System Diagnostics](#).
Depending on the results of the diagnostics test, proceed as needed through the following steps.
2. If your system has a RAID controller and your hard drives are configured in a RAID array, perform the following steps:
 - a. Reboot the system and press <F10> during system startup to run the Lifecycle Controller, and then run the Hardware Configuration wizard to check the RAID configuration.
See the Lifecycle Controller documentation or online help for information on RAID configuration.
 - b. Ensure that the hard drive(s) are configured correctly for the RAID array.
 - c. Take the hard drive offline and reseat the drive.
 - d. Exit the configuration utility and allow the system to boot to the operating system.
3. Ensure that the required device drivers for your controller card are installed and are configured correctly. See the operating system documentation for more information.
4. Reboot the system and enter the System Setup.
5. Verify that the controller is enabled and the drives are displayed in the System Setup.

Next steps

If the problem persists, try troubleshooting the expansion cards or see [Getting Help](#).

Troubleshooting a storage controller

 **CAUTION:** Many repairs may only be done by a certified service technician. You should only perform troubleshooting and simple repairs as authorized in your product documentation, or as directed by the online or telephone service and support team. Damage due to servicing that is not authorized by Dell is not covered by your warranty. Read and follow the safety instructions that came with the product.

 **NOTE:** When troubleshooting a SAS or PERC controller, see the documentation for your operating system and the controller.

1. Run the appropriate diagnostic test. For more information, see [Using System Diagnostics](#).
2. Turn off the system and attached peripherals, and disconnect the system from the electrical outlet.
3. Remove the system cover.
4. Verify that the installed expansion cards are compliant with the expansion card installation guidelines.
5. Ensure that each expansion card is firmly seated in its connector.
6. Install the system cover.
7. Reconnect the system to the electrical outlet, and turn on the system and attached peripherals.
8. If the problem is not resolved, turn off the system and attached peripherals, and disconnect the system from the electrical outlet.
9. Remove the system cover.
10. Remove all expansion cards installed in the system.
11. Install the system cover.
12. Reconnect the system to the electrical outlet, and turn on the system and attached peripherals.
13. Run the appropriate diagnostic test. For more information, see [Using System Diagnostics](#). If the tests fail, see [Getting Help](#).
14. For each expansion card you removed in step 10, perform the following steps:
 - a. Turn off the system and attached peripherals, and disconnect the system from the electrical outlet.
 - b. Remove the system cover.
 - c. Reinstall one of the expansion cards.
 - d. Install the system cover.
 - e. Run the appropriate diagnostic test. For more information, see [Using System Diagnostics](#).

If the tests fail, see [Getting Help](#).

Troubleshooting expansion cards

Prerequisites

 **CAUTION:** Many repairs may only be done by a certified service technician. You should only perform troubleshooting and simple repairs as authorized in your product documentation, or as directed by the online or telephone service and support team. Damage due to servicing that is not authorized by Dell is not covered by your warranty. Read and follow the safety instructions that came with the product.

 **NOTE:** When troubleshooting an expansion card, see the documentation for your operating system and the expansion card.

Steps

1. Run the appropriate diagnostic test. For more information, see [Using System Diagnostics](#).
2. Turn off the system and attached peripherals, and disconnect the system from the electrical outlet.
3. Remove the system cover.
4. Ensure that each expansion card is firmly seated in its connector.
5. Install the system cover.
6. If the problem is not resolved, turn off the system and attached peripherals, and disconnect the system from the electrical outlet.
7. Remove the system cover.
8. Remove all expansion cards installed in the system.
9. Install the system cover.
If the tests fail, see [Getting Help](#).
10. For each expansion card you removed in step 8, perform the following steps:
 - a. Turn off the system and attached peripherals, and disconnect the system from the electrical outlet.
 - b. Remove the system cover.
 - c. Reinstall one of the expansion cards.
 - d. Install the system cover.
 - e. Run the appropriate diagnostic test. For more information, see [Using System Diagnostics](#).

Next steps

If the problem persists, see [Getting Help](#).

Troubleshooting processors

Prerequisites



CAUTION: Many repairs may only be done by a certified service technician. You should only perform troubleshooting and simple repairs as authorized in your product documentation, or as directed by the online or telephone service and support team. Damage due to servicing that is not authorized by Dell is not covered by your warranty. Read and follow the safety instructions that came with the product.

Steps

1. Run the appropriate diagnostics test. See [Using System Diagnostics](#) for available diagnostic tests.
2. Turn off the system and attached peripherals, and disconnect the system from the electrical outlet.
3. Remove the system cover.
4. Ensure that the processor and heat sink are properly installed.
5. Install the system cover.
6. Run the appropriate diagnostic test. For more information, see [Using System Diagnostics](#).

Next steps

If the problem persists, see [Getting Help](#).

System messages

For a list of event and error messages generated by the system firmware and agents that monitor system components, see the Dell Event and Error Messages Reference Guide at dell.com/esmanuals.

Warning messages

A warning message alerts you to a possible problem and prompts you to respond before the system continues a task. For example, before you format a hard drive, a message warns you that you may lose all data on the hard drive. Warning messages usually interrupt the task and require you to respond by typing y (yes) or n (no).

 **NOTE:** Warning messages are generated by either the application or the operating system. For more information, see the documentation that accompanied the operating system or application.

Diagnostic messages

The system diagnostic utilities may issue messages if you run diagnostic tests on your system. See the [Using system diagnostics](#) for more information about system diagnostics.

Alert messages

The systems management software generates alert messages for your system. Alert messages include information, status, warning, and failure messages for drive, temperature, fan, and power conditions. For more information, see the systems management software documentation.

Using system diagnostics

If you experience a problem with your system, run the system diagnostics before contacting Dell for technical assistance. The purpose of running system diagnostics is to test your system hardware without requiring additional equipment or risking data loss. If you are unable to fix the problem yourself, service and support personnel can use the diagnostics results to help you solve the problem.

Dell Embedded System Diagnostics

 **NOTE:** The Dell Embedded System Diagnostics is also known as Enhanced Pre-boot System Assessment (ePSA) diagnostics.

The embedded system diagnostics provides a set of options for particular device groups or devices allowing you to:

- Run tests automatically or in an interactive mode
- Repeat tests
- Display or save test results
- Run thorough tests to introduce additional test options to provide extra information about the failed device(s)
- View status messages that inform you if tests are completed successfully
- View error messages that inform you of problems encountered during testing

When to use the Embedded System Diagnostics

If a major component or device in the system does not operate properly, running the embedded system diagnostics may indicate component failure.

Running the Embedded System Diagnostics from Boot Manager

1. As the system boots, press <F11>.
2. Use the up and down arrow keys to select **System Utilities** → **Launch Diagnostics**.
The **ePSA Pre-boot System Assessment** window is displayed, listing all devices detected in the system. The diagnostics starts executing the tests on all the detected devices.

Running the Embedded System Diagnostics from the Dell Lifecycle Controller

1. As the system boots, press <F11>.
2. Select **Hardware Diagnostics** → **Run Hardware Diagnostics**.
The **ePSA Pre-boot System Assessment** window is displayed, listing all devices detected in the system. The diagnostics starts executing the tests on all the detected devices.

System diagnostic controls

Menu	Description
Configuration	Displays the configuration and status information of all detected devices.
Results	Displays the results of all tests that are executed.
System health	Provides the current overview of the system performance.
Event log	Displays a time-stamped log of the results of all tests run on the system. This is displayed if at least one event description is recorded.





For information about embedded system diagnostics, see the *ePSA Diagnostics Guide (Notebooks, Desktops and Servers)* at dell.com/support/manuals.

Jumpers and connectors

System board jumper settings

For information on resetting the password jumper to disable a password, see [Disabling a forgotten password](#).

Table 6. System board jumper settings

Jumper	Setting	Description
PWRD_EN	 2 4 6 (default) (default)	The password feature is enabled (pins 4–6).
	 2 4 6	The password feature is disabled (pins 2–4). iDRAC local access is unlocked at the next AC power cycle.
NVRAM_CLR	 1 3 5 (default) (default)	The configuration settings are retained at system boot (pins 1–3).
	 1 3 5	The configuration settings are cleared at the next system boot (pins 3–5).

System board connectors

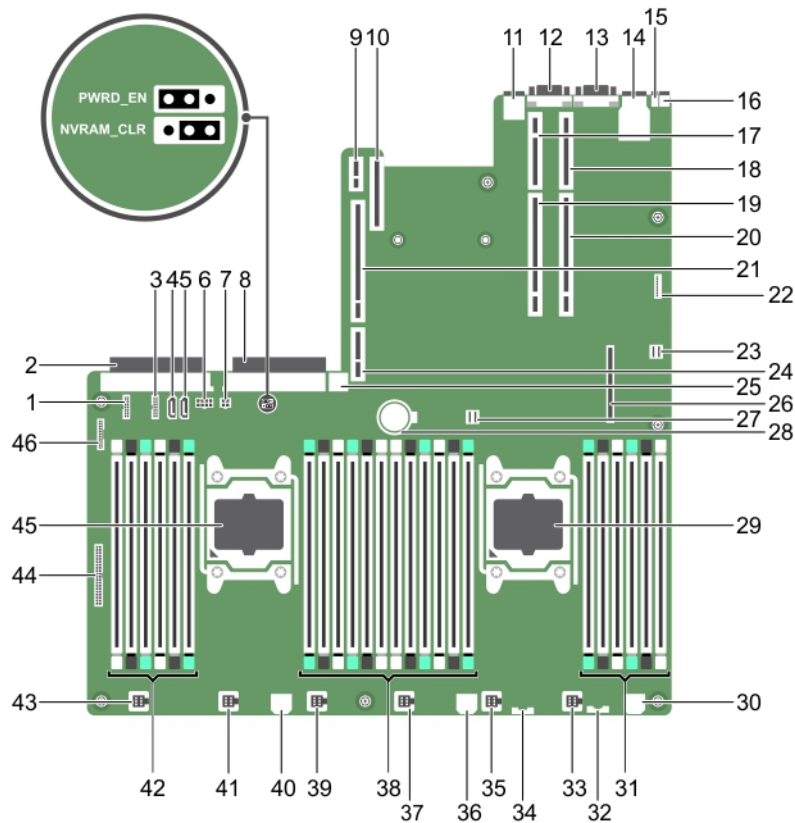

Figure 59. System board connectors and jumpers

Item	Connector	Description
1.	J_BP_SIG1	Backplane signal connector 1
2.	J_PS2	PSU 2 power connector
3.	J_BP_SIG0	Backplane signal connector 0
4.	J_SATA_CD	Optical drive SATA connector
5.	J_SATA_TBU	SATA tape backup unit connector
6.	J_BP0	Backplane power connector
7.	J_TBU	Tape backup unit power connector
8.	J_PS1	PSU 2 power connector
9.	J_IDSMD	Internal dual SD module connector
10.	J_NDC	Network daughter card connector

Item	Connector	Description
11	J_USB	USB connector
12	J_VIDEO_REAR	Video connector
13	J_COM1	Serial connector
14	J_IDRAC_RJ45	iDRAC7 connector
15	J_CYC	System identification connector
16	CYC_ID	System identification button
17	J_RISER_2AX	Riser 2 connector
18	J_RISER_1AX	Riser 1 connector
19	J_RISER_2BX	Riser 2 connector
20	J_RISER_1BX	Riser 1 connector
21	J_RISER_3AX	Riser 3 connector
22	J_SATA_B	SATA connector
23	J_QS	Quick Sync connector
24	J_RISER_3BX	Riser 3 connector
25	J_USB_INT	Internal USB connector
26	J_STORAGE	Storage controller card connector
27	J_SATA_A	SATA connector
28	BAT	Battery connector
29	CPU2	Processor socket 2
30	J_FAN1U_7	Cooling fan connector
31	B1, B5, B9, B2, B6, B10	Memory module sockets
32	J_BP3	Hard-drive backplane power connector
33	J_FAN1U_6	Cooling fan connector
34	J_BP_SIG2	Backplane signal connector 2
35	J_FAN1U_5	Cooling fan connector
36	J_BATT_SIG	Battery signal connector
37	J_FAN1U_4	Cooling fan connector
38	A1, A5, A9, A2, A6, A10, B3, B7, B11, B4, B8, B12	Memory module sockets
39	J_FAN1U_3	Cooling fan connector
40	J_FAN2U	Cooling fan connector
41	J_FAN1U_2	Cooling fan connector
42	A12, A8, A4, A7, A11, A3	Memory module sockets

Item	Connector	Description
43	J_FAN1U_1	Cooling fan connector
44	J_CTRL_PNL	Control panel connector
45	CPU1	Processor socket 1
46	J_FP_USB	Front panel USB connector

Disabling a forgotten password

The system's software security features include a system password and a setup password. The password jumper enables these password features or disables them and clears any password(s) currently in use.

Prerequisites

 **CAUTION:** Many repairs may only be done by a certified service technician. You should only perform troubleshooting and simple repairs as authorized in your product documentation, or as directed by the online or telephone service and support team. Damage due to servicing that is not authorized by Dell is not covered by your warranty. Read and follow the safety instructions that came with the product.

Steps



1. Turn off the system, including any attached peripherals, and disconnect the system from the electrical outlet.
2. Open the system.
3. Move the jumper on the system-board jumper from pins 4 and 6 to pins 2 and 4.
4. Close the system.

The existing passwords are not disabled (erased) until the system boots with the jumper on pins 2 and 4. However, before you assign a new system and/or setup password, you must move the jumper back to pins 4 and 6.

 **NOTE:** If you assign a new system and/or setup password with the jumper on pins 2 and 4, the system disables the new password(s) the next time it boots.

5. Reconnect the system to its electrical outlet and turn the system on, including any attached peripherals.
6. Turn off the system, including any attached peripherals, and disconnect the system from the electrical outlet.
7. Open the system.
8. Move the jumper on the system-board jumper from pins 2 and 4 to pins 4 and 6.
9. Close the system.
10. Reconnect the system to its electrical outlet and turn the system on, including any attached peripherals.
11. Assign a new system and/or setup password.

Technical specifications

Processor	
Processor type	One or two Intel Xeon processor E5-2600 v3 product family
Expansion Bus	
Bus type	PCI Express Generation 3
Expansion cards	For a list of supported expansion cards, see Expansion card installation guidelines .
Expansion slots using riser card:	
Riser 1	(Slot 1) One half-height, three fourth-length x8 link
	(Slot 2) One half-height, half-length x16 link
Riser 2	(Slot 1) One half-height, half-length x8 link or one half-height, half-length x8 link
	 NOTE: Both processors must be installed to use the slots on riser 1 and the x16 link on riser 2.
	(Slot 2) One half-height, half-length x8 link or one half-height, half-length x16 link
Riser 3	(Slot 2) One half-height, half-length x8 link or one half-height, half-length x16 link
Power	
AC power supply (per power supply)	
Wattage	495 W, 750 W, or 1100 W
Heat dissipation	1908 BTU/hr maximum (495 W power supply)
	 NOTE: Heat dissipation is calculated using the power supply wattage rating.
	2891 BTU/hr maximum (750 W power supply)
	2843 BTU/hr maximum (750 W Titanium power supply)
	4100 BTU/hr maximum (1100 W power supply)
Voltage	100–240 V AC, autoranging, 50/60 Hz
	or

Power



NOTE: This system is also designed to be connected to IT power systems with a phase to phase voltage not exceeding 230 V.

200–240 V AC, autoranging, 50/60 Hz, for 750 W Titanium power supply

Memory

Architecture	1866 MT/ and 2133 MT/s registered Error Correcting Code (ECC) DIMMs Support for Advanced ECC or memory-optimized operation Support for LRDIMMs
Memory module sockets	Twenty-four 288-pin
Memory module capacities	
LRDIMM	4 GB, 8 GB, 16 GB, or 32 GB single-, dual-, or quad-ranked
RDIMM	4 GB, 8 GB, or 32 GB single-, dual-, or quad-ranked 16 GB single- or dual-ranked
Minimum RAM	2 GB with a single processor 4 GB with two processors
Maximum RAM	
LRDIMM	Up to 768 GB
RDIMM	Up to 512 GB

Drives

Hard drives	
8–hard-drive systems	Up to eight 2.5 inch, internal, hot-swappable SAS, SATA, or Nearline SAS hard drives
10–hard-drive systems	Up to ten 2.5 inch, internal, hot-swappable SAS, SATA, or Nearline SAS hard drives
24–hard-drive systems	Up to 24 1.8 inch, internal, hot-swappable SAS, SATA, or Nearline SAS hard drives
Optical drive (8 hard-drive systems only)	One optional SATA DVD-ROM drive or DVD+/-RW drive



NOTE: DVD devices are data only.

Connectors

Back

NIC	Four 10/100/1000 Mbps or two 10/100/1000 Mbps and two 100 Mbps/1 Gbps/10 Gbps
Serial	DB-9 Serial Port connector
USB	Two 4-pin, USB 3.0-compliant
Video	15-pin VGA

Front**8 hard-drive systems**

USB	Two 4-pin, USB 3.0-compliant
Video	15-pin VGA
External vFlash card	vFlash memory card slot



NOTE: The card slot is available for use only if the iDRAC8 Enterprise license is installed on your system.

10 hard-drive systems

USB	One mini USB 3.0-compliant
-----	----------------------------

Internal

USB	One 4-pin, USB 3.0-compliant
Internal Dual SD Module (IDSDM)	Two optional flash memory card slots with the internal SD module



NOTE: One card slot is dedicated for redundancy.

Video

Video type	Integrated VGA controller
Video memory	16 MB shared

Expanded Operating Temperature



NOTE: When operating in the expanded temperature range, system performance may be impacted.



NOTE: When operating in the expanded temperature range, ambient temperature warnings may be reported on the LCD and in the System Event Log.

≤ 10% of annual operating hours	Continuous Operation 5°C to 40°C at 5% to 85% RH with 29°C dew point.
---------------------------------	---

Expanded Operating Temperature

 **NOTE:** Outside the standard operating temperature (10°C to 35°C), the system can operate continuously down to 5°C or as high as 40°C.

For temperatures between 35°C and 40°C, de-rate maximum allowable temperature by 1°C per 175 m above 950 m (1°F per 319 ft).

≤ 1% of annual operating hours

–5°C to 45°C at 5% to 90% RH with 29°C (84.2°F) maximum dew point.

 **NOTE:** Outside the standard operating temperature (10°C to 35°C), the system can operate down to –5°C or up to 45°C for a maximum of 1% of its annual operating hours.

For temperatures between 40 °C and 45 °C, de-rate maximum allowable dry bulb temperature by 1°C per 125 m above 950 m (1°F per 228 ft).

Expanded Operating Temperature Restrictions

- Do not perform a cold startup below 5°C.
- The operating temperature specified is for a maximum altitude of 3048 m (10,000 ft).
- PCIe SSD and 1.8 inch SSDs are not supported.
- GPU is not supported.
- 145 W and Workstation CPU (160 W) processors are not supported.
- Two power supply units are required and one power supply unit failure is not supported.
- Non Dell qualified peripheral cards and/or peripheral cards greater than 25 W are not supported.

Environmental

 **NOTE:** For additional information about environmental measurements for specific system configurations, see [dell.com/environmental_datasheets](https://www.dell.com/environmental_datasheets).

Temperature

Maximum temperature gradient (operating and storage) 20°C/h (36°F/h)

Storage temperature limits –40°C to 65°C (–40°F to 149°F)

Relative humidity

Storage 5% to 95% RH with 33°C (91 °F) maximum dew point. Atmosphere must be non-condensing at all times.

Temperature (continuous operation)

Environmental

Temperature ranges (for altitude less than 950 m or 3117 ft) 10°C to 35°C (50°F to 95°F) with no direct sunlight on the equipment.

Humidity percentage range 10% to 80% Relative Humidity with 26°C (78.8°F) maximum dew point.

Maximum vibration

Operating 0.26 G_{rms} at 5 Hz to 350 Hz (all operation orientations).

Storage 1.87 G_{rms} at 10 Hz to 500 Hz for 15 min (all six sides tested).

Maximum shock

Operating One shock pulse in the positive z axis of 31 G for 2.6 ms in all operational orientations.

Storage Six consecutively executed shock pulses in the positive and negative x, y, and z axes (one pulse on each side of the system) of 71 G for up to 2 ms.

Maximum altitude

Operating 3,048 m (10,000 ft)

Storage 12,000 m (39,370 ft).

Operating altitude de-rating

Up to 35°C (95°F) Maximum temperature is reduced by 1°C/300 m (1°F/547 ft) above 950 m (3,117 ft).

35°C to 40°C (95°F to 104°F) Maximum temperature is reduced by 1°C/175 m (1°F/319 ft) above 950 m (3,117 ft).

40°C to 45°C (104°F to 113°F) Maximum temperature is reduced by 1°C/125 m (1°F/228 ft) above 950 m (3,117 ft).

Particulate contamination

 **NOTE:** This section defines the limits to help avoid IT equipment damage and/or failure from particulates and gaseous contamination. If it is determined that levels of particulates or gaseous pollution are beyond the limits specified below and are the reason for the damage and/or failures to your equipment, it may be necessary for you to re-mediate the environmental conditions that are causing the damage and/or failures. Re-mediation of environmental conditions will be the responsibility of the customer.

Air filtration Data center air filtration as defined by ISO Class 8 per ISO 14644-1 with a 95% upper confidence limit.

 **NOTE:** Air entering the data center must have MERV11 or MERV13 filtration.

Environmental

 **NOTE:** Applies to data center environments only. Air filtration requirements do not apply to IT equipment designed to be used outside a data center, in environments such as an office or factory floor.

Conductive dust

Air must be free of conductive dust, zinc whiskers, or other conductive particles.

 **NOTE:** Applies to data center and non-data center environments.

Corrosive dust

- Air must be free of corrosive dust.
- Residual dust present in the air must have a deliquescent point less than 60% relative humidity.

 **NOTE:** Applies to data center and non-data center environments.

Gaseous contamination

 **NOTE:** Maximum corrosive contaminant levels measured at $\leq 50\%$ relative humidity.

Copper coupon corrosion rate

$< 300 \text{ \AA/month}$ per Class G1 as defined by ANSI/ISA71.04-1985.

Silver coupon corrosion rate

$< 200 \text{ \AA/month}$ as defined by AHSRAE TC9.9.

Getting help

Contacting Dell

About this task

 **NOTE:** Dell provides several online and telephone-based support and service options. If you do not have an active Internet connection, you can find contact information on your purchase invoice, packing slip, bill, or Dell product catalog. Availability varies by country and product, and some services may not be available in your area.

To contact Dell for sales, technical support, or customer-service issues:

Steps

1. Go to **dell.com/support**.
2. Select your country from the drop-down menu on the top left corner of the page.
3. For customized support:
 - a. Enter your system service tag in the **Enter your Service Tag** field.
 - b. Click **Submit**.The support page that lists the various support categories is displayed.
4. For general support:
 - a. Select your product category.
 - b. Select your product segment.
 - c. Select your product.The support page that lists the various support categories is displayed.

Locating your system service tag

Your system is identified by a unique Express Service Code and Service Tag number. The Express Service Code and Service Tag are found on the front of the system by pulling out the information tag. Alternatively, the information may be on a sticker on the chassis of the system. This information is used by Dell to route support calls to the appropriate personnel.

Documentation feedback

If you have feedback for this document, write to **documentation_feedback@dell.com**. Alternatively, you can click on the **Feedback** link in any of the Dell documentation pages, fill out the form, and click **Submit** to send your feedback.

Quick Resource Locator

Use the Quick Resource Locator (QRL) to get immediate access to system information and how-to videos. This can be done by visiting **dell.com/QRL** or by using your smartphone or tablet and a model

specific Quick Resource (QR) code located on your Dell PowerEdge system. To try out the QR code, scan the following image.

